

REACTOR™

312065V

Electric, Heated, Plural Component Proportioner

EN

For spraying polyurethane foam and polyurea coatings. For professional use only.

Not approved for use in explosive atmospheres or hazardous (classified) locations.



Important Safety Instructions

Read all warnings and instructions in this manual before using the equipment.
Save these instructions.

Model E-XP1 Shown

See page 4 for model information, including maximum working pressure and approvals.

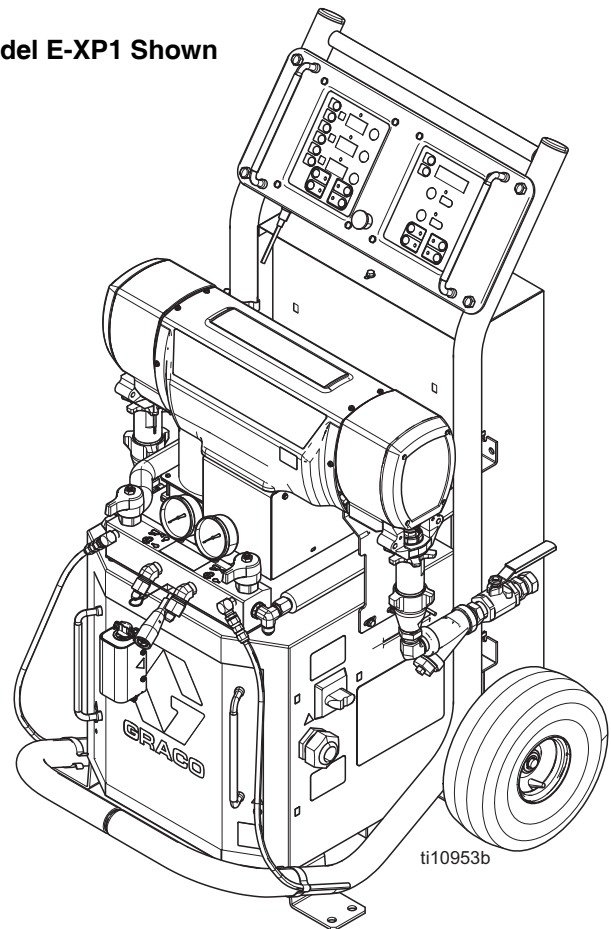

Contents

Systems	3	Setup	19
Models	4	Locate Reactor	19
Approvals	4	General equipment guidelines	19
Supplied Manuals	5	Grounding	20
Related Manuals	5	Electrical requirements	20
Warnings	6	Connect electrical cord	21
Important Isocyanate (ISO) Information	10	Connect feed pumps	21
Isocyanate Conditions	10	Connect pressure relief lines	21
Material Self-Ignition	11	Install Fluid Temperature Sensor (FTS)	22
Keep Components A and B Separate	11	Connect heated hose	22
Moisture Sensitivity of Isocyanates	11	Supply wet cups with Throat Seal Liquid (TSL)	24
Foam Resins with 245 fa Blowing Agents	11	Operation	25
Changing Materials	11	Pressure Relief Procedure	25
Typical Installation, with circulation	12	Flush the Equipment	25
Typical Installation, without circulation	13	Startup	26
Component Identification	14	Load fluid with feed pumps	26
Temperature Controls and Indicators	15	Set temperatures	27
Main Power Switch	15	Set pressure	28
Red Stop Button	15	Change pressure imbalance setting (optional) ..	29
Actual Temperature Key/LED	16	Spraying	29
Target Temperature Key/LED	16	Shutdown	30
Temperature Scale Keys/LEDs	16	Fluid Circulation	31
Heater Zone On/Off Keys/LEDs	16	Circulation Through Reactor	31
Temperature Arrow Keys	16	Circulation Through Gun Manifold	32
Temperature Displays	16	Jog Mode	33
Circuit Breakers	16	Diagnostic Codes	34
Motor Controls and Indicators	17	Temperature Control Diagnostic Codes	34
Motor ON/OFF Key/LED	17	Motor Control Diagnostic Codes	34
PARK Key/LED	17	Maintenance	35
PSI/BAR Keys/LEDs	17	Fluid Inlet Strainer Screen	35
Pressure Key/LED	17	Pump Lubrication System	36
Cycle Count Key/LED	17	Accessories	37
Pressure Arrow Keys	18	Dimensions	38
Pressure/Cycle Display	18	Technical Specifications	39
Spray Adjustments	18	California Proposition 65	41
		Graco Standard Warranty	42
		Graco Information	42

Systems

Part	Maximum Fluid Working Pressure psi (MPa, bar)	Proportioner (see page 4)	Heated Hose			Gun		Mix Chamber Kit
			50 ft (15 m)	Qty	10 ft (3 m) (Qty 1)	Model	Part (Qty 1)	
AP9024	2500 (17.2, 172)	259024	246679	1	246055	Fusion® AP	246100	AR2020
AP9025	2000 (13.8, 138)	259025	246678	1	246050	Fusion AP	246101	AR5252
AH9025	2000 (13.8, 138)	259025	246678	4	246050	Fusion AP	246100	AR5252
AP9026	2000 (13.8, 138)	259026	246678	1	246050	Fusion AP	246101	AR5252
AP9028	3500 (24.1, 241)	259028	246679	1	246055	Fusion AP	246100	AR2020
AP9029	2500 (17.2, 172)	259029	246679	1	246055	Fusion AP	246100	AR2020
AP9030	2000 (13.8, 138)	259030	246678	1	246050	Fusion AP	246101	AR5252
AH9030	2000 (13.8, 138)	259030	246678	4	246050	Fusion AP	246100	AR5252
AP9031	2000 (13.8, 138)	259031	246678	1	246050	Fusion AP	246101	AR5252
AP9032	3500 (24.1, 241)	259032	246679	1	246055	Fusion AP	246100	AR2020
AP9033	2500 (17.2, 172)	259033	246679	1	246055	Fusion AP	246100	AR2020
AP9034	2000 (13.8, 138)	259034	246678	1	246050	Fusion AP	246101	AR5252
AH9034	2000 (13.8, 138)	259034	246678	4	246050	Fusion AP	246100	AR5252
AP9035	2000 (13.8, 138)	259035	246678	1	246050	Fusion AP	246101	AR5252
AP9036	3500 (24.1, 241)	259036	246679	1	246055	Fusion AP	246100	AR2020
AP9057	2000 (13.8, 138)	259057	246678	1	246050	Fusion AP	246101	AR5252
AP9058	2000 (13.8, 138)	259058	246678	1	246050	Fusion AP	246101	AR5252
AP9059	2000 (13.8, 138)	259059	246678	1	246050	Fusion AP	246101	AR5252
CS9025	2000 (13.8, 138)	259025	246678	1	246050	Fusion CS	CS01RD	
CH9025	2000 (13.8, 138)	259025	246678	4	246050	Fusion CS	CS01RD	
CS9026	2000 (13.8, 138)	259026	246678	1	246050	Fusion CS	CS02RD	
CS9030	2000 (13.8, 138)	259030	246678	1	246050	Fusion CS	CS01RD	
CH9030	2000 (13.8, 138)	259030	246678	4	246050	Fusion CS	CS01RD	
CS9031	2000 (13.8, 138)	259031	246678	1	246050	Fusion CS	CS02RD	
CS9034	2000 (13.8, 138)	259034	246678	1	246050	Fusion CS	CS01RD	
CH9034	2000 (13.8, 138)	259034	246678	4	246050	Fusion CS	CS01RD	
CS9035	2000 (13.8, 138)	259035	246678	1	246050	Fusion CS	CS02RD	
CS9057	2000 (13.8, 138)	259057	246678	1	246050	Fusion CS	CS02RD	
CS9058	2000 (13.8, 138)	259058	246678	1	246050	Fusion CS	CS02RD	
CS9059	2000 (13.8, 138)	259059	246678	1	246050	Fusion CS	CS02RD	
P29024	2500 (17.2, 172)	259024	246679	1	246055	Probler P2	GCP2RA	
P29025	2000 (13.8, 138)	259025	246678	1	246050	Probler P2	GCP2R1	
PH9025	2000 (13.8, 138)	259025	246678	4	246050	Probler P2	GCP2R1	
P29026	2000 (13.8, 138)	259026	246678	1	246050	Probler P2	GCP2R2	
P29028	3500 (24.1, 241)	259028	246679	1	246055	Probler P2	GCP2R0	
P29029	2500 (17.2, 172)	259029	246679	1	246055	Probler P2	GCP2RA	
P29030	2000 (13.8, 138)	259030	246678	1	246050	Probler P2	GCP2R1	
PH9030	2000 (13.8, 138)	259030	246678	4	246050	Probler P2	GCP2R1	
P29031	2000 (13.8, 138)	259031	246678	1	246050	Probler P2	GCP2R2	
P29032	3500 (24.1, 241)	259032	246679	1	246055	Probler P2	GCP2R0	
P29033	2500 (17.2, 172)	259033	246679	1	246055	Probler P2	GCP2RA	
P29034	2000 (13.8, 138)	259034	246678	1	246050	Probler P2	GCP2R1	
PH9034	2000 (13.8, 138)	259034	246678	4	246050	Probler P2	GCP2R1	
P29035	2000 (13.8, 138)	259035	246678	1	246050	Probler P2	GCP2R2	
P29036	3500 (24.1, 241)	259036	246679	1	246055	Probler P2	GCP2R0	
P29057	2000 (13.8, 138)	259057	246678	1	246050	Probler P2	GCP2R2	
P29058	2000 (13.8, 138)	259058	246678	1	246050	Probler P2	GCP2R2	
P29059	2000 (13.8, 138)	259059	246678	1	246050	Probler P2	GCP2R2	
FH9025	2000 (13.8, 138)	259025	246678	4	25P770	Fusion PC	25P588	PC52RD
FH9030	2000 (13.8, 138)	259030	246678	4	25P770	Fusion PC	25P588	PC52RD
FH9034	2000 (13.8, 138)	259034	246678	4	25P770	Fusion PC	25P588	PC52RD
FH9024	2500 (17.2, 172)	259024	246679	1	25P772	Fusion PC	25P587	PC20RD
FH9025	2000 (13.8, 138)	259025	246678	1	25P770	Fusion PC	25P588	PC52RD
FH9029	2500 (17.2, 172)	259029	246679	1	25P772	Fusion PC	25P587	PC20RD
FH9030	2000 (13.8, 138)	259030	246678	1	25P770	Fusion PC	25P588	PC52RD
FH9033	2500 (17.2, 172)	259033	246679	1	25P772	Fusion PC	25P587	PC20RD
FH9034	2000 (13.8, 138)	259034	246678	1	25P770	Fusion PC	25P588	PC52RD

Models

E-20 SERIES

Part, Series	Full Load Peak Amps*	Nominal Voltage Range (phase)	System Watts†	Primary Heater Watts	Max Flow Rate◆ lb/min (kg/min)	Approximate Output per Cycle (A+B) gal. (liter)	Maximum Fluid Working Pressure psi (MPa, bar)
259025, G	48	200-240 V (1)	10,200	6,000	20 (9)	0.0104 (0.0395)	2000 (14, 140)
259030, G	24	350-415 V (3)	10,200	6,000	20 (9)	0.0104 (0.0395)	2000 (14, 140)
259034, G	32	200-240 V (3)	10,200	6,000	20 (9)	0.0104 (0.0395)	2000 (14, 140)

E-30 SERIES

Part, Series	Full Load Peak Amps*	Nominal Voltage Range (phase)	System Watts†	Primary Heater Watts	Max Flow Rate◆ lb/min (kg/min)	Approximate Output per Cycle (A+B) gal. (liter)	Maximum Fluid Working Pressure psi (MPa, bar)
259026, F	78	200-240 V (1)	17,900	10,200	30 (13.5)	0.0272 (0.1034)	2000 (14, 140)
259031, F	34	350-415 V (3)	17,900	10,200	30 (13.5)	0.0272 (0.1034)	2000 (14, 140)
259035, F	50	200-240 V (3)	17,900	10,200	30 (13.5)	0.0272 (0.1034)	2000 (14, 140)
259057, F	100	200-240 V (1)	23,000	15,300	30 (13.5)	0.0272 (0.1034)	2000 (14, 140)
259058, F	62	200-240 V (3)	23,000	15,300	30 (13.5)	0.0272 (0.1034)	2000 (14, 140)
259059, F	35	350-415 V (3)	23,000	15,300	30 (13.5)	0.0272 (0.1034)	2000 (14, 140)

E-XP1 SERIES

Part, Series	Full Load Peak Amps*	Nominal Voltage Range (phase)	System Watts†	Primary Heater Watts	Max Flow Rate◆ gpm (lpm)	Approximate Output per Cycle (A+B) gal. (liter)	Maximum Fluid Working Pressure psi (MPa, bar)
259024, G	69	200-240 V (1)	15,800	10,200	1.0 (3.8)	0.0104 (0.0395)	2500 (17.2, 172)
259029, G	24	350-415 V (3)	15,800	10,200	1.0 (3.8)	0.0104 (0.0395)	2500 (17.2, 172)
259033, G	43	200-240 V (3)	15,800	10,200	1.0 (3.8)	0.0104 (0.0395)	2500 (17.2, 172)

E-XP2 SERIES

Part, Series	Full Load Peak Amps*	Nominal Voltage Range (phase)	System Watts†	Primary Heater Watts	Max Flow Rate◆ gpm (lpm)	Approximate Output per Cycle (A+B) gal. (liter)	Maximum Fluid Working Pressure psi (MPa, bar)
259028, F	100	200-240 V (1)	23,000	15,300	2.0 (7.6)	0.0203 (0.0771)	3500 (24.1, 241)
259032, F	35	350-415 V (3)	23,000	15,300	2.0 (7.6)	0.0203 (0.0771)	3500 (24.1, 241)
259036, F	62	200-240 V (3)	23,000	15,300	2.0 (7.6)	0.0203 (0.0771)	3500 (24.1, 241)

* Full load amps with all devices operating at maximum capabilities. Fuse requirements at various flow rates and mix chamber sizes may be less.

† Total system watts, based on maximum hose length for each unit:

- E-20 and E-XP1 series, 210 ft (64 m) maximum heated hose length, including whip hose.
- E-30 and E-XP2 series, 310 ft (94.5 m) maximum heated hose length, including whip hose.

◆ Maximum flow rate given for 60 Hz operation. For 50 Hz operation, maximum flow rate is 5/6 of 60 Hz maximum flow.

Approvals



Intertek
9902741

Conforms to ANSI/UL
Std. 499 Certified to
CAN/CSA Std.
C22.2 No. 88

Supplied Manuals

The following manuals are shipped with the Reactor Proportioner. Refer to these manuals for detailed equipment information.

Manuals are also available at www.graco.com.

Manual in English	Description
312066	Reactor Electric Proportioner, Repair-Parts Manual
312067	Reactor Electric Proportioner, Electrical Diagrams
309577	Electric Reactor Displacement Pump Repair-Parts Manual

Related Manuals

The following manuals are for accessories used with the Reactor.

Manual in English	Description
309867	Reactor Data Reporting Kit, Instruction-Parts Manual
309550	Fusion AP Spray Gun, Instruction-Parts Manual
312666	Fusion CS Spray Gun, Instruction-Parts Manual
313213	Probler P2 Spray Gun, Instruction-Parts Manual
309572	Heated Hose, Instruction-Parts Manual
309852	Circulation and Return Tube Kit, Instruction-Parts Manual
312416	Rupture Disk Assembly Kit, Instruction-Parts Manual
310815	Electric Reactor Installation, Instruction Manual



Warnings

The following warnings are for the setup, use, grounding, maintenance, and repair of this equipment. The exclamation point symbol alerts you to a general warning and the hazard symbol refers to procedure-specific risk. Refer back to these warnings. Additional, product-specific warnings may be found throughout the body of this manual where applicable.

DANGER

	<p>SEVERE ELECTRIC SHOCK HAZARD</p> <p>This equipment can be powered by more than 240 V. Contact with this voltage will cause death or serious injury.</p> <ul style="list-style-type: none"> Turn off and disconnect power at main switch before disconnecting any cables and before servicing equipment. This equipment must be grounded. Connect only to grounded power source. All electrical wiring must be done by a qualified electrician and comply with all local codes and regulations.
---	---

WARNING

	<p>TOXIC FLUID OR FUMES HAZARD</p> <p>Toxic fluids or fumes can cause serious injury or death if splashed in the eyes or on skin, inhaled or swallowed.</p> <ul style="list-style-type: none"> Read Safety Data Sheets (SDSs) for handling instructions and to know the specific hazards of the fluids you are using, including the effects of long-term exposure. When spraying, servicing equipment, or when in the work area, always keep work area well-ventilated and always wear appropriate personal protective equipment. See Personal Protective Equipment warnings in this manual. Store hazardous fluid in approved containers, and dispose of it according to applicable guidelines.
	<p>PERSONAL PROTECTIVE EQUIPMENT</p> <p>Always wear appropriate personal protective equipment and cover all skin when spraying, servicing equipment, or when in the work area. Protective equipment helps prevent serious injury, including long-term exposure; inhalation of toxic fumes, mists or vapors; allergic reaction; burns; eye injury and hearing loss. This protective equipment includes but is not limited to:</p> <ul style="list-style-type: none"> A properly fitting respirator, which may include a supplied-air respirator, chemically impermeable gloves, protective clothing and foot coverings as recommended by the fluid manufacturer and local regulatory authority. Protective eyewear and hearing protection.

! WARNING



SKIN INJECTION HAZARD

High-pressure fluid from dispensing device, hose leaks, or ruptured components will pierce skin. This may look like just a cut, but it is a serious injury that can result in amputation. **Get immediate surgical treatment.**



- Engage trigger lock when not dispensing.
- Do not point dispensing device at anyone or at any part of the body.
- Do not put your hand over the fluid outlet.
- Do not stop or deflect leaks with your hand, body, glove, or rag.
- Follow the **Pressure Relief Procedure** when you stop dispensing and before cleaning, checking, or servicing equipment.
- Tighten all fluid connections before operating the equipment.
- Check hoses and couplings daily. Replace worn or damaged parts immediately.



FIRE AND EXPLOSION HAZARD







Flammable fumes, such as solvent and paint fumes, in **work area** can ignite or explode. Paint or solvent flowing through the equipment can cause static sparking. To help prevent fire and explosion:





- Use equipment only in well-ventilated area.
- Eliminate all ignition sources; such as pilot lights, cigarettes, portable electric lamps, and plastic drop cloths (potential static sparking).
- Ground all equipment in the work area. See **Grounding** instructions.
- Never spray or flush solvent at high pressure.
- Keep work area free of debris, including solvent, rags and gasoline.
- Do not plug or unplug power cords, or turn power or light switches on or off when flammable fumes are present.
- Use only grounded hoses.
- Hold gun firmly to side of grounded pail when triggering into pail. Do not use pail liners unless they are anti-static or conductive.
- **Stop operation immediately** if static sparking occurs or you feel a shock. Do not use equipment until you identify and correct the problem.
- Keep a working fire extinguisher in the work area.



WARNING

  	<p>THERMAL EXPANSION HAZARD</p> <p>Fluids subjected to heat in confined spaces, including hoses, can create a rapid rise in pressure due to the thermal expansion. Over-pressurization can result in equipment rupture and serious injury.</p> <ul style="list-style-type: none"> • Open a valve to relieve the fluid expansion during heating. • Replace hoses proactively at regular intervals based on your operating conditions.
	<p>PRESSURIZED ALUMINUM PARTS HAZARD</p> <p>Use of fluids that are incompatible with aluminum in pressurized equipment can cause serious chemical reaction and equipment rupture. Failure to follow this warning can result in death, serious injury, or property damage.</p> <ul style="list-style-type: none"> • Do not use 1,1,1-trichloroethane, methylene chloride, other halogenated hydrocarbon solvents or fluids containing such solvents. • Do not use chlorine bleach. • Many other fluids may contain chemicals that can react with aluminum. Contact your material supplier for compatibility.
 	<p>EQUIPMENT MISUSE HAZARD</p> <p>Misuse can cause death or serious injury.</p> <ul style="list-style-type: none"> • Do not operate the unit when fatigued or under the influence of drugs or alcohol. • Do not exceed the maximum working pressure or temperature rating of the lowest rated system component. See Technical Specifications in all equipment manuals. • Use fluids and solvents that are compatible with equipment wetted parts. See Technical Specifications in all equipment manuals. Read fluid and solvent manufacturer's warnings. For complete information about your material, request Safety Data Sheets (SDSs) from distributor or retailer. • Do not leave the work area while equipment is energized or under pressure. • Turn off all equipment and follow the Pressure Relief Procedure when equipment is not in use. • Check equipment daily. Repair or replace worn or damaged parts immediately with genuine manufacturer's replacement parts only. • Do not alter or modify equipment. Alterations or modifications may void agency approvals and create safety hazards. • Make sure all equipment is rated and approved for the environment in which you are using it. • Use equipment only for its intended purpose. Call your distributor for information. • Route hoses and cables away from traffic areas, sharp edges, moving parts, and hot surfaces. • Do not kink or over bend hoses or use hoses to pull equipment. • Keep children and animals away from work area. • Comply with all applicable safety regulations.

WARNING

 	<p>MOVING PARTS HAZARD</p> <p>Moving parts can pinch, cut or amputate fingers and other body parts.</p> <ul style="list-style-type: none"> • Keep clear of moving parts. • Do not operate equipment with protective guards or covers removed. • Equipment can start without warning. Before checking, moving, or servicing equipment, follow the Pressure Relief Procedure and disconnect all power sources.
	<p>BURN HAZARD</p> <p>Equipment surfaces and fluid that is heated can become very hot during operation. To avoid severe burns:</p> <ul style="list-style-type: none"> • Do not touch hot fluid or equipment.

Important Isocyanate (ISO) Information

Isocyanates (ISO) are catalysts used in two component materials.

Isocyanate Conditions

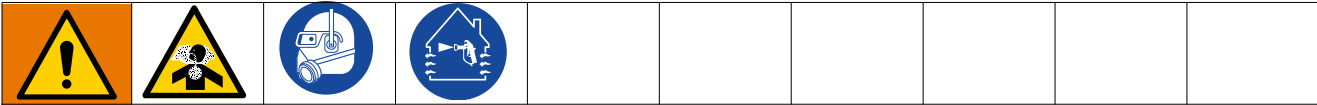

Spraying or dispensing fluids that contain isocyanates creates potentially harmful mists, vapors, and atomized particulates.

- Read and understand the fluid manufacturer’s warnings and Safety Data Sheets (SDSs) to know specific hazards and precautions related to isocyanates.
- Use of isocyanates involves potentially hazardous procedures. Do not spray with this equipment unless you are trained, qualified, and have read and understood the information in this manual and in the fluid manufacturer’s application instructions and SDSs.
- Use of incorrectly maintained or mis-adjusted equipment may result in improperly cured material, which could cause off gassing and offensive odors. Equipment must be carefully maintained and adjusted according to instructions in the manual.
- To prevent inhalation of isocyanate mists, vapors and atomized particulates, everyone in the work area must wear appropriate respiratory protection. Always wear a properly fitting respirator, which may include a supplied-air respirator. Ventilate the work area according to instructions in the fluid manufacturer’s SDSs.
- Avoid all skin contact with isocyanates. Everyone in the work area must wear chemically impermeable gloves, protective clothing and foot coverings as recommended by the fluid manufacturer and local regulatory authority. Follow all fluid manufacturer recommendations, including those regarding handling of contaminated clothing. After spraying, wash hands and face before eating or drinking.
- Hazard from exposure to isocyanates continues after spraying. Anyone without appropriate personal protective equipment must stay out of the work area during application and after application for the time period specified by the fluid manufacturer. Generally this time period is at least 24 hours.
- Warn others who may enter work area of hazard from exposure to isocyanates. Follow the recommendations of the fluid manufacturer and local regulatory authority. Posting a placard such as the following outside the work area is recommended:

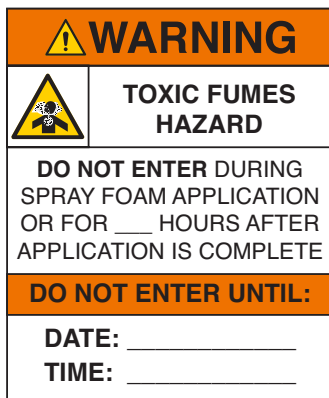

Material Self-Ignition



Some materials may become self-igniting if applied too thick. Read material manufacturer's warnings and Safety Data Sheets (SDSs).

Keep Components A and B Separate



Cross-contamination can result in cured material in fluid lines which could cause serious injury or damage equipment. To prevent cross-contamination:

- **Never** interchange component A and component B wetted parts.
- Never use solvent on one side if it has been contaminated from the other side.

Moisture Sensitivity of Isocyanates

Exposure to moisture (such as humidity) will cause ISO to partially cure, forming small, hard, abrasive crystal that become suspended in the fluid. Eventually a film will form on the surface and the ISO will begin to gel, increasing in viscosity.

NOTICE

Partially cured ISO will reduce performance and the life of all wetted parts.

- Always use a sealed container with a desiccant dryer in the vent, or a nitrogen atmosphere. **Never** store ISO in an open container.
- Keep the ISO pump wet cup or reservoir (if installed) filled with appropriate lubricant. The lubricant creates a barrier between the ISO and the atmosphere.
- Use only moisture-proof hoses compatible with ISO.
- Never use reclaimed solvents, which may contain moisture. Always keep solvent containers closed when not in use.
- Always lubricate threaded parts with an appropriate lubricant when reassembling.

NOTE: The amount of film formation and rate of crystallization varies depending on the blend of ISO, the humidity, and the temperature.

Foam Resins with 245 fa Blowing Agents

Some foam blowing agents will froth at temperatures above 90°F (33°C) when not under pressure, especially if agitated. To reduce frothing, minimize preheating in a circulation system.

Changing Materials

NOTICE

Changing the material types used in your equipment requires special attention to avoid equipment damage and downtime.

- When changing materials, flush the equipment multiple times to ensure it is thoroughly clean.
- Always clean the fluid inlet strainers after flushing.
- Check with your material manufacturer for chemical compatibility.
- When changing between epoxies and urethanes or polyureas, disassemble and clean all fluid components and change hoses. Epoxies often have amines on the B (hardener) side. Polyureas often have amines on the B (resin) side.

Typical Installation, with circulation

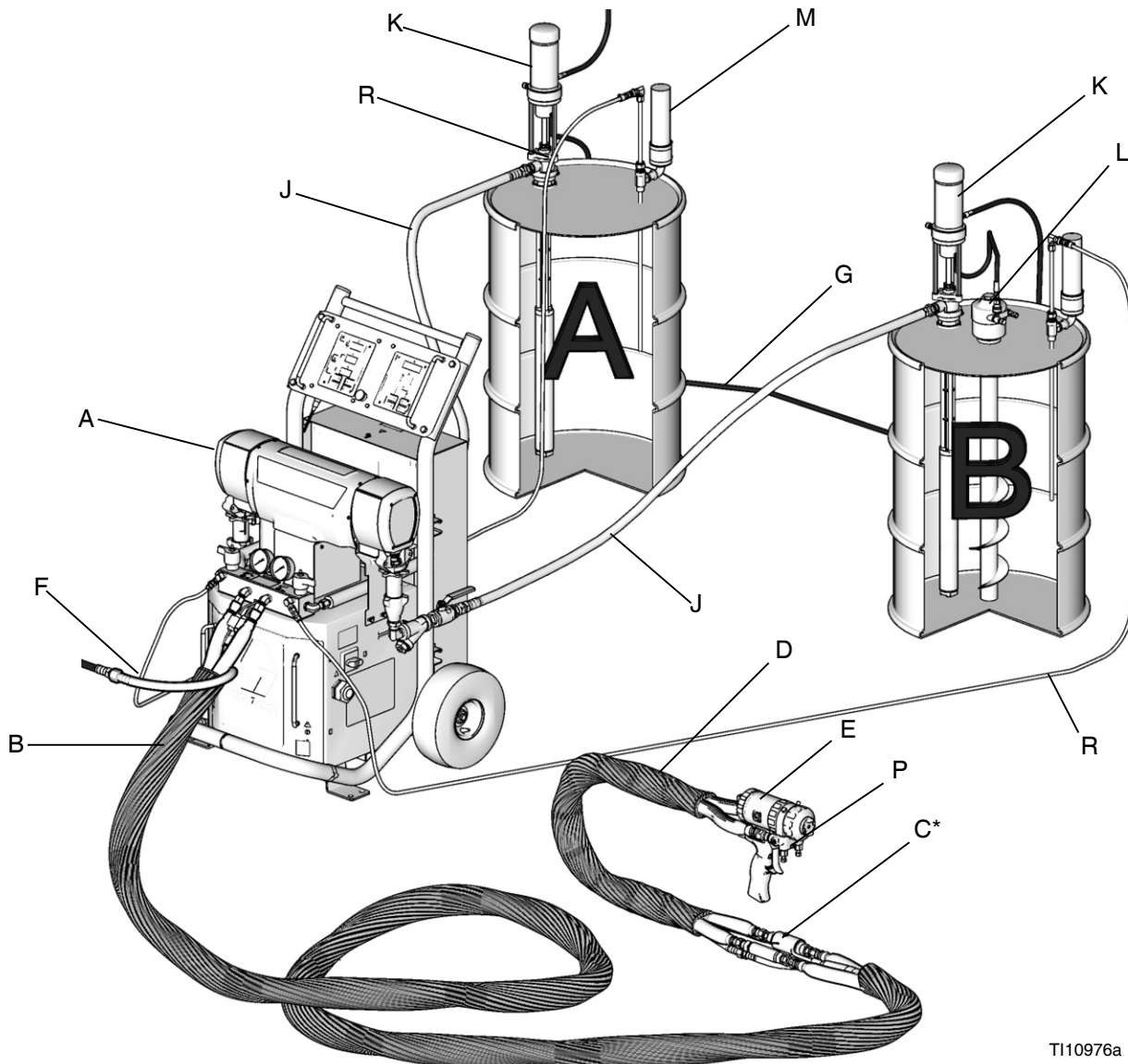

T110976a

* Shown exposed for clarity. Wrap with tape during operation,

Fig. 1: Typical Installation, with circulation

Key

- | | | | |
|---|--------------------------------|---|----------------------------------|
| A | Reactor Proportioner | G | Feed Pump Air Supply Lines |
| B | Heated Hose | J | Fluid Supply Lines |
| C | Fluid Temperature Sensor (FTS) | K | Feed Pumps |
| D | Heated Whip Hose | L | Agitator |
| E | Fusion Spray Gun | M | Desiccant Dryer |
| F | Gun Air Supply Hose | P | Gun Fluid Manifold (part of gun) |
| | | R | Circulation Lines |

Typical Installation, without circulation

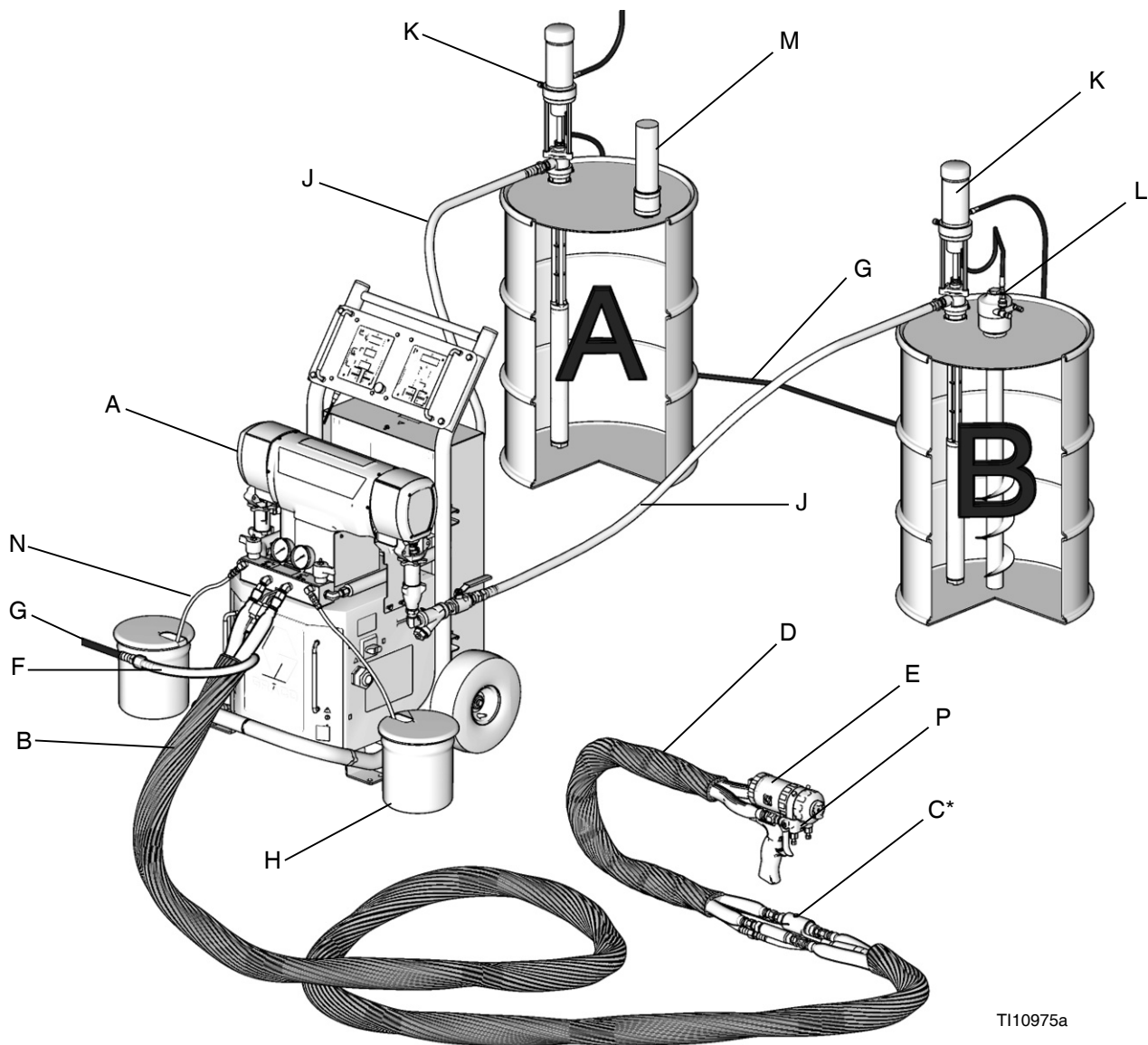

* Shown exposed for clarity. Wrap with tape during operation,

FIG. 2: Typical Installation, without circulation

Key

- | | | | |
|---|--------------------------------|---|----------------------------------|
| A | Reactor Proportioner | H | Waste Containers |
| B | Heated Hose | J | Fluid Supply Lines |
| C | Fluid Temperature Sensor (FTS) | K | Feed Pumps |
| D | Heated Whip Hose | L | Agitator |
| E | Fusion Spray Gun | M | Desiccant Dryer |
| F | Gun Air Supply Hose | N | Bleed Lines |
| G | Feed Pump Air Supply Lines | P | Gun Fluid Manifold (part of gun) |
| | | R | Air Filter/Separator |

Component Identification

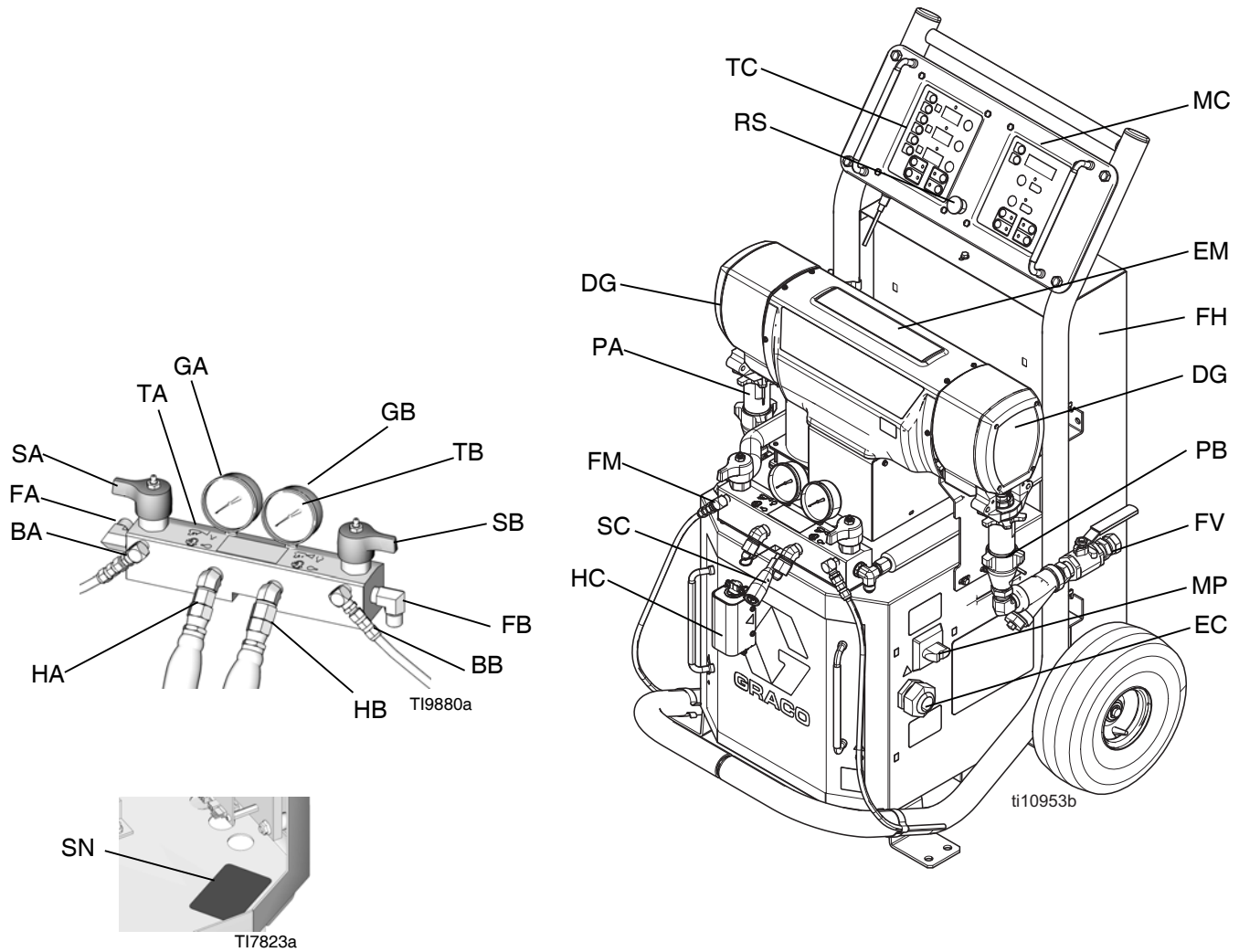

Fig. 3: Component Identification (Model EXP-1 Shown)

Key

- BA Component A Pressure Relief Outlet
- BB Component B Pressure Relief Outlet
- FA Component A Fluid Manifold Inlet (behind manifold block)
- FB Component B Fluid Manifold Inlet
- GA Component A Pressure Gauge
- GB Component B Pressure Gauge
- HA Component A Hose Connection
- HB Component B Hose Connection
- PA Component A Pump
- PB Component B Pump
- SA Component A PRESSURE RELIEF/SPRAY Valve
- SB Component B PRESSURE RELIEF/SPRAY Valve
- TA Component A Pressure Transducer (behind gauge GA)
- TB Component B Pressure Transducer (behind gauge GB)

- DG Drive Gear Housing
- EC Electrical Cord Strain Relief
- EM Electric Motor
- FH Fluid Heaters (behind shroud)
- FM Reactor Fluid Manifold
- FV Fluid Inlet Valve (B side shown)
- HC Heated Hose Termination Box (series F)
- MC Motor Control Display
- MP Main Power Switch
- RS Red Stop Button
- SC Fluid Temperature Sensor Cable
- SN Serial No. Plate
- TC Temperature Control Display

Temperature Controls and Indicators

NOTICE
To prevent damage to the softkey buttons, do not press the buttons with sharp objects such as pens, plastic cards, or fingernails.

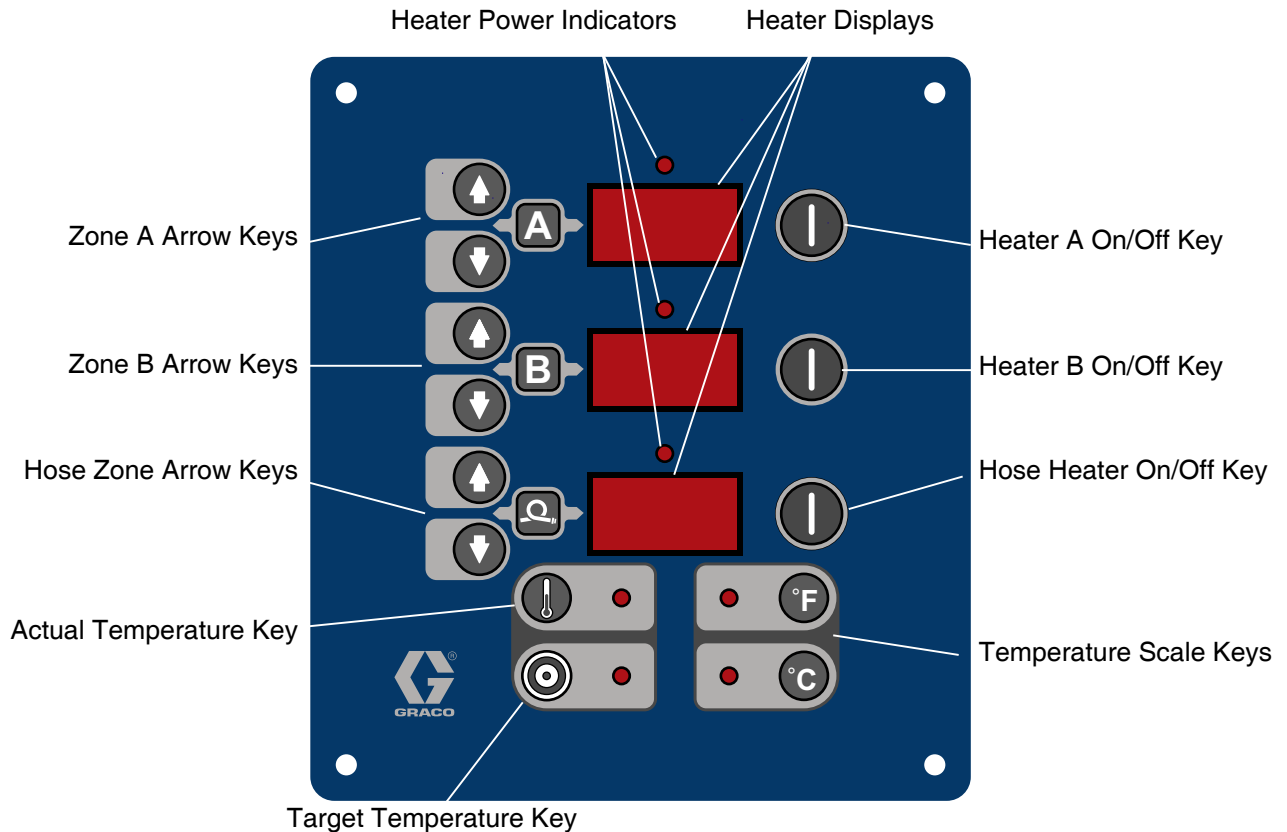



FIG. 4: Temperature Controls and Indicators

Main Power Switch

Located on right side of unit, see FIG. 3, page 14. Turns

Reactor power ON  and OFF . Does not turn heater zones or pumps on.

Red Stop Button

Located between temperature control panel and motor control panel see FIG. 3, page 14. Press  to shut off motor and heater zones only. Use main power switch to shut off all power to unit.

Actual Temperature Key/LED

Press  to display actual temperature.



Press and hold  to display electrical current.

Target Temperature Key/LED

Press  to display target temperature.

Press and hold  to display heater control circuit board temperature.

Temperature Scale Keys/LEDs



Press  or  to change temperature scale.

Heater Zone On/Off Keys/LEDs

Press  to turn heater zones on and off. Also clears heater zone diagnostic codes, see **Temperature Control Diagnostic Codes**, page 34.

NOTE: LEDs flash when heater zones are on. The duration of each flash shows the extent that the heater is turned on.

Temperature Arrow Keys

Press , then press  or  to adjust temperature settings in 1 degree increments.

Temperature Displays

Show actual temperature or target temperature of heater zones, depending on selected mode. Defaults to actual at startup. Range is 32-190°F (0-88°C) for A and B, 32-180°F (0-82°C) for hose.

Circuit Breakers



Located inside Reactor cabinet.

Ref.	Size	Component
CB1	50 A	Hose/Transformer Secondary
CB2	40 A	Transformer Primary
CB3	25, 40*	Heater A
CB4	25, 40*	Heater B
CB5	20	Motor/Pumps

* Depending on model.

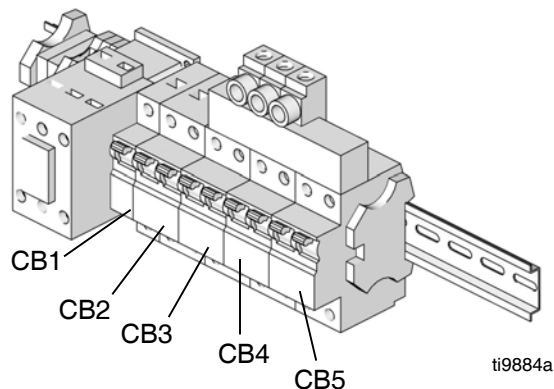

For wiring and cabling, see repair manual 312066.

Motor Controls and Indicators

NOTICE
To prevent damage to the softkey buttons, do not press the buttons with sharp objects such as pens, plastic cards, or fingernails.

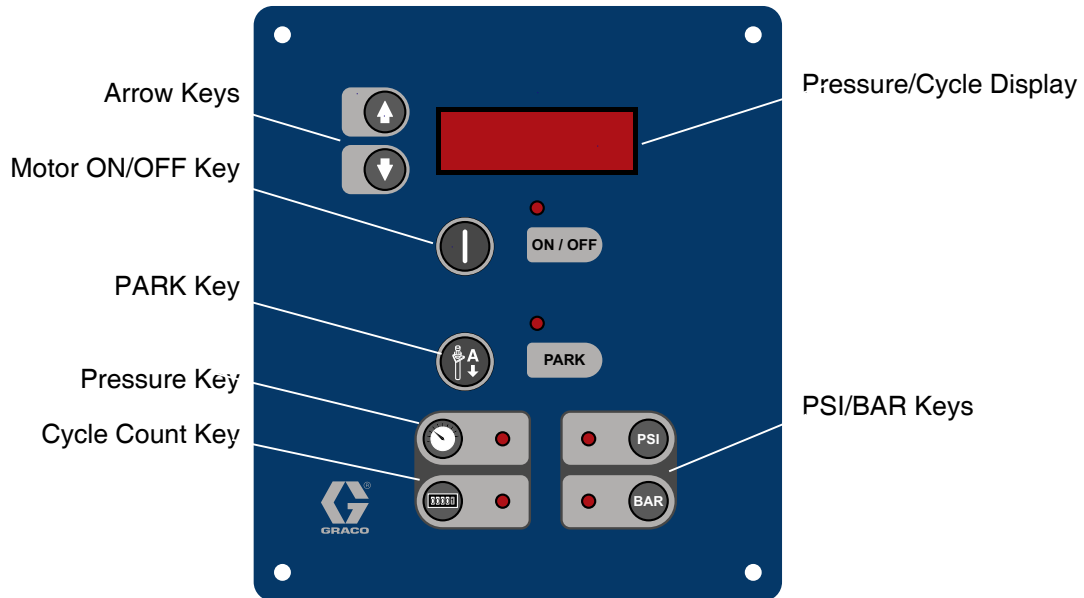



FIG. 5: Motor Controls and Indicators



Motor ON/OFF Key/LED

Press  to turn motor ON and OFF. Also clears some motor control diagnostic codes, see **Motor Control Diagnostic Codes**, page 34.

PARK Key/LED

Press  at end of day to cycle component A pump to home position, submerging displacement rod. Trigger gun until pump stops. Once parked, motor will automatically shut off.

PSI/BAR Keys/LEDs

Press  or  to change pressure scale.

Pressure Key/LED

Press  to display fluid pressure.



NOTE: If pressures are imbalanced, display shows higher of two pressures.



Cycle Count Key/LED

Press  to display cycle count.

NOTE: To clear counter, press and hold  for 3 sec.

Pressure Arrow Keys

Press  or  to adjust fluid pressure when motor is ON. Setpoint displays for 10 sec.

When motor is OFF, pressing  will enter jog mode. To exit jog mode, press  until display shows dashes or current pressure.

Pressure/Cycle Display

Shows fluid pressure or cycle count, depending on mode selected.

Displays J 1 through J 10 when in jog mode, page 33.

Spray Adjustments

Flow rate, atomization, and amount of overspray are affected by four variables.

- **Fluid pressure setting.** Too little pressure results in an uneven pattern, coarse droplet size, low flow, and poor mixing. Too much pressure results in excessive overspray, high flow rates, difficult control, and excessive wear.
- **Fluid temperature.** Similar effects to fluid pressure setting. The A and B temperatures can be offset to help balance the fluid pressure.
- **Mix chamber size.** Choice of mix chamber is based on desired flow rate and fluid viscosity.
- **Clean-off air adjustment.** Too little clean-off air results in droplets building up on the front of the nozzle, and no pattern containment to control overspray. Too much clean-off air results in air-assisted atomization and excessive overspray.

Setup

NOTICE

Proper system setup, start up, and shutdown procedures are critical to electrical equipment reliability. The following procedures ensure steady voltage. Failure to follow these procedures will cause voltage fluctuations that can damage electrical equipment and void the warranty.

Locate Reactor

1. Locate Reactor on a level surface. See **Dimensions**, page 38, for clearance and mounting hole dimensions.
2. Do not expose Reactor to rain.

NOTICE

To prevent damage from tipping over and falling, proper care needs to be taken when lifting the Reactor. Bolt Reactor to original shipping pallet, to keep stable, before lifting.

3. Use the casters to move Reactor to a fixed location, or bolt to shipping pallet and move with forklift.
4. To mount on a truck bed or trailer, remove casters and secure rear axle with 15B805 mobile mounting bracket (MB), available separately. Bolt bracket and mounting feet (MF) directly to truck or trailer bed. See **Dimensions**, page 38.

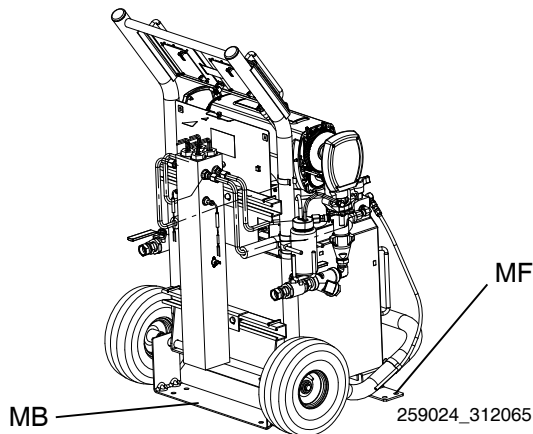

FIG. 6

General equipment guidelines

- Determine the correct size generator. Using the correct size generator and proper air compressor will enable the proportioner to run at a nearly constant RPM. Failure to do so will cause voltage fluctuations that can damage electrical equipment. Ensure the generator matches the voltage and phase of the proportioner.

Use the following procedure to determine the correct size generator.

- a. List system components that use peak load requirements in watts.
- b. Add the wattage required by the system components.
- c. Perform the following equation:
Total watts x 1.25 = kVA (kilovolt-amperes)
- d. Select a generator size that is equal to or greater than the determined kVA.

- Size the power cord using the full load peak amps listed in TABLE 1, page 20. Failure to do so will cause voltage fluctuations that can damage electrical equipment.
- Use an air compressor with constant speed head unloading devices. Direct online air compressors that start and stop during a job will cause voltage fluctuations that can damage electrical equipment.
- Maintain and inspect the generator, air compressor, and other equipment per the manufacturer recommendations to avoid an unexpected shutdown. Unexpected equipment shutdown will cause voltage fluctuations that can damage electrical equipment.
- Use a wall power supply with enough current to meet system requirements. Failure to do so will cause voltage fluctuations that can damage electrical equipment.

Grounding



- **Reactor:** is grounded through power cord. See **Connect electrical cord**, page 21.
- **Spray gun:** connect whip hose ground wire to FTS, see **Install Fluid Temperature Sensor (FTS)**, page 22. Do not disconnect wire or spray without whip hose.
- **Fluid supply containers:** follow your local code.
- **Object being sprayed:** follow your local code.
- **Solvent pails used when flushing:** follow your local code. Use only metal pails, which are conductive, placed on a grounded surface. Do not place pail on a nonconductive surface, such as paper or cardboard, which interrupts grounding continuity
- **To maintain grounding continuity when flushing or relieving pressure,** hold a metal part of spray gun firmly to the side of a grounded *metal* pail, then trigger gun.

Electrical requirements



Installing this equipment requires access to parts which may cause electric shock or other serious injury if work is not performed properly. Have a qualified electrician connect power and ground, see **Connect electrical cord**, page 21. Be sure your installation complies with all local codes and regulations.

Table 1: Electrical Requirements (kW/Full Load Amps)

E SERIES				
Part	Model	Nominal Voltage Range (phase)	Full Load Peak Amps*	System Watts**
259025	E-20	200-240 V (1)	48	10,200
249030	E-20	350-415 V (3)	24	10,200
259034	E-20	200-240 V (3)	32	10,200
259026	E-30	200-240 V (1)	78	17,900
259031	E-30	350-415 V (3)	34	17,900
259035	E-30	200-240 V (3)	50	17,900
259057	E-30†	200-240 V (1)	100	23,000
259058	E-30†	200-240 V (3)	62	23,000
259059	E-30†	350-415 V (3)	35	23,000
E-XP SERIES				
259024	E-XP1	200-240 V (1)	69	15,800
259029	E-XP1	350-415 V (3)	24	15,800
259033	E-XP1	200-240 V (3)	43	15,800
259028	E-XP2	200-240 V (1)	100	23,000
259032	E-XP2	350-415 V (3)	35	23,000
259036	E-XP2	200-240 V (3)	62	23,000

* Full load amps with all devices operating at maximum capabilities. Fuse requirements at various flow rates and mix chamber sizes may be less.

** E-20 and E-XP1 with 210 ft (64.1 m) hose; E-30 and E-XP2 with 310 ft (94.6 m) hose.

† E-30 with 15.3 kW of heat.

Connect electrical cord



NOTE: Power cord is not supplied.

1. **200-240 V ac, 1-phase:** Using 5/32 or 4 mm hex allen wrench, connect two power leads to L1 and L2. Connect green to ground (GND).

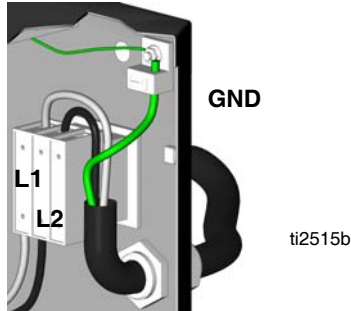

2. **200-240 V ac, 3-phase:** Using 5/32 or 4 mm hex allen wrench, connect three power leads to L1, L2, and L3. Connect green to ground (GND).

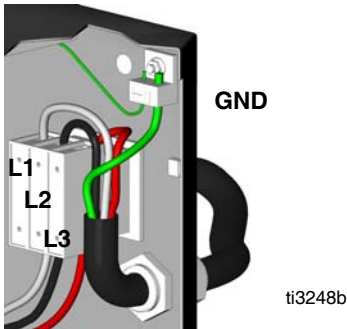

3. **350-415 V ac, 3-phase:** Using 5/32 or 4 mm hex allen wrench, connect three power leads to L1, L2, and L3. Connect neutral to N. Connect green to ground (GND).

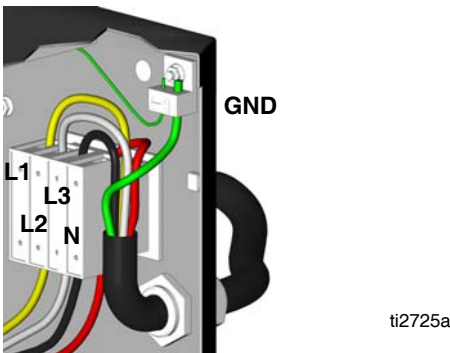

Connect feed pumps

1. Install feed pumps (K) in component A and B supply drums. See FIG. 1 and FIG. 2, pages 12 and 13.
2. Seal component A drum and use desiccant dryer (M) in vent.
3. Install agitator (L) in component B drum, if necessary.
4. Ensure A and B inlet valves (FV) are closed.

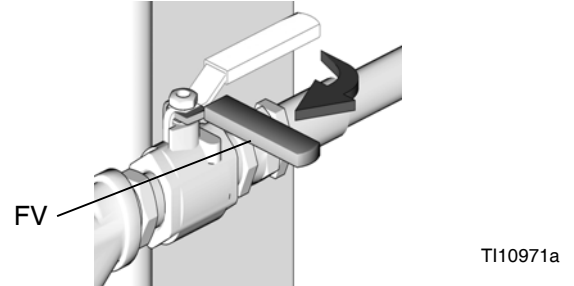

NOTE: Supply hoses from feed pumps should be 3/4 in. (19 mm) ID.

Connect pressure relief lines



Do not install shutoffs downstream of the PRESSURE RELIEF/SPRAY valve outlets (BA, BB). The valves function as overpressure relief valves

when set to SPRAY . Lines must be open so valves can automatically relieve pressure when machine is operating.

If circulating fluid back to the supply drums, use high pressure hose rated to withstand the maximum working pressure of this equipment.

1. **Recommended:** Connect high pressure hose (R) to relief fittings (BA, BB) of both PRESSURE

RELIEF/SPRAY valves, Route hose back to component A and B drums. See FIG. 1, page 12.

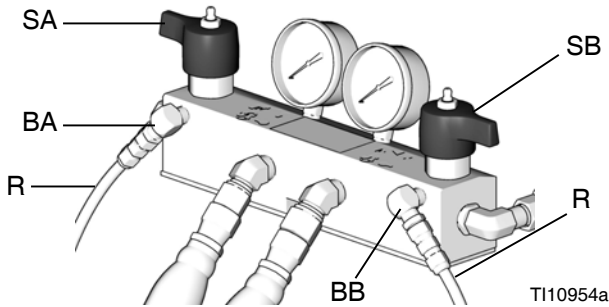

2. **Alternately:** Secure supplied bleed tubes (N) in grounded, sealed waste containers (H). See FIG. 2, page 13.

Install Fluid Temperature Sensor (FTS)

The Fluid Temperature Sensor (FTS) is supplied. Install FTS between main hose and whip hose. See Heated Hose manual 309572 for instructions.

Connect heated hose

NOTE: See Heated Hose manual 309572 for detailed instructions on connecting heated hoses.

NOTE: The fluid temperature sensor (C) and whip hose (D) must be used with heated hose, see page 22. Hose length, including whip hose, must be 60 ft (18.3 m) minimum.

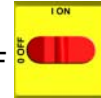

1. Turn main power OFF
2. Assemble heated hose sections, FTS, and whip hose.
3. Grease with Fusion grease and connect fluid hoses to proportioner fluid manifold (M): red for hardener (ISO, blue for resin (RES)).

NOTE: The manifold hose adapters (N, P) allow use of 1/4 in. (6.4 mm) and 3/8 in. (9.5 mm) ID fluid hoses. To check adapter tightness, torque 1/4 in. and 3/8 in. ID hoses to:

- A side (HA) to 14 ft-lb (19 N•m).
- B side (HB) to 20 ft-lb (27 N•m).

NOTE: To use 1/2 in. (13 mm) ID fluid hoses, remove the adapters (N, P) from the proportioner fluid manifold and install them in the FTS or 3/8 in. ID hose inlets. Torque 1/2 in. ID hoses to:

- A side (HA) to 43 ft-lb (58 N•m).
- B side (HB) to 55 ft-lb (74 N•m).

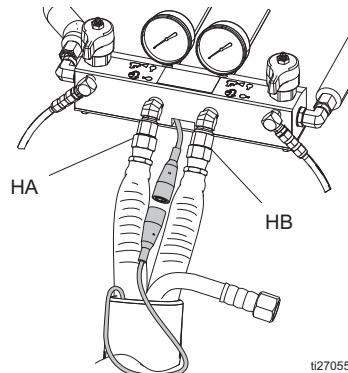

NOTE: For proportioners with a termination box (TB), follow step 8d. For proportioners with electrical splice connectors (v), follow step 5.

4. Connect hose power wires to the terminal block (C) on the termination box (TB).
 - a. Remove box cover (D) and loosen lower strain relief (E).
 - b. Route wires through strain relief and fully insert into terminal block (A and B hose wire positions are not important).
 - c. Torque terminal block screws (C) to 35-50 in-lb (4.0-5.6 N•m).
 - d. Fully tighten strain relief screws and replace cover.

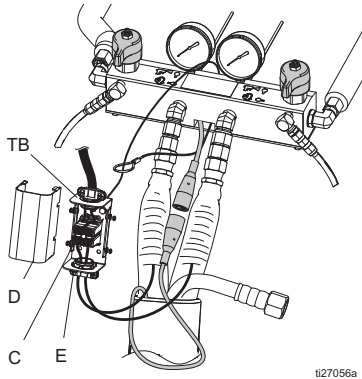

5. Connect hose power wires to electrical splice connectors (V) from proportioner. Wrap connections with electrical tape.

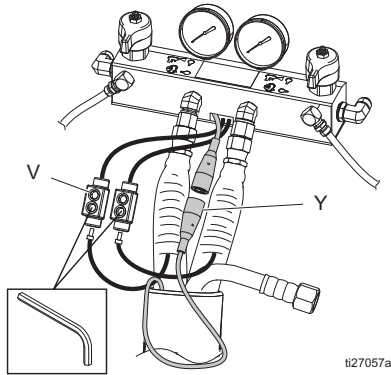

6. Connect FTS cable connectors (Y). Fully tighten connectors and slide connector covers over the joint.
7. Check that all equipment is properly grounded. See proportioner manual.
8. Close gun fluid manifold valves A and B

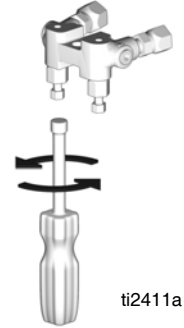

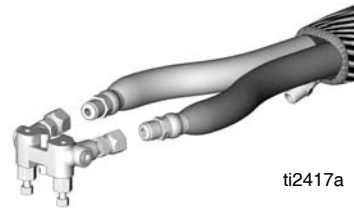

9. Connect whip hose to gun fluid manifold

NOTE: Do not connect manifold to gun.



10. Pressure check the hose for leaks. See hose manual. If no leaks, wrap hose and electrical connections to protect from damage.

Supply wet cups with Throat Seal Liquid (TSL)

				
<p>Pump rod and connecting rod move during operation. Moving parts can cause serious injury such as pinching or amputation. Keep hands and fingers away from wet-cup during operation. Turn main power OFF before filling wet cup.</p>				
				

1. **Component A (ISO) Pump:** Keep reservoir (R) filled with Graco Throat Seal Liquid (TSL), Part 206995. Wet-cup piston circulates TSL through wet-cup, to carry away isocyanate film on displacement rod.

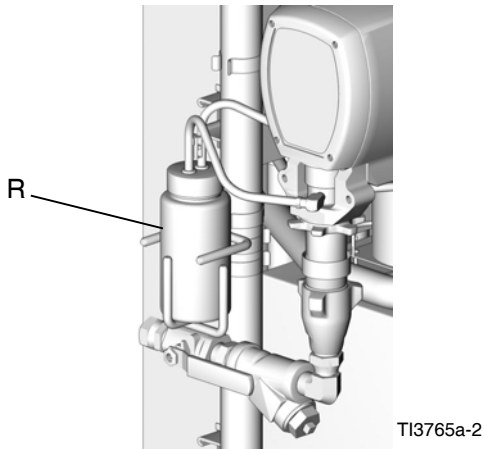

FIG. 7

2. **Component B (Resin) Pump:** Check felt washers in packing nut/wet-cup (S) daily. Keep saturated with Graco Throat Seal Liquid (TSL), Part No. 206995, to prevent material from hardening on displacement rod. Replace felt washers when worn or contaminated with hardened material.

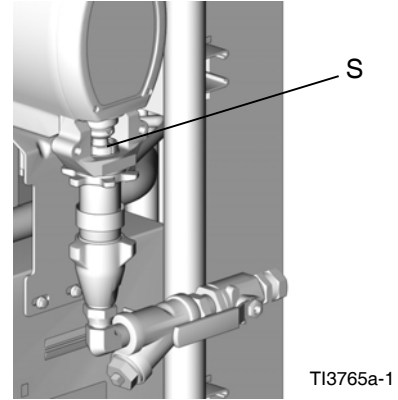

FIG. 8

Operation

Pressure Relief Procedure



Follow the Pressure Relief Procedure whenever you see this symbol.



This equipment stays pressurized until pressure is manually relieved. To help prevent serious injury from pressurized fluid, such as skin injection, splashing fluid and moving parts, follow the Pressure Relief Procedure when you stop spraying and before cleaning, checking, or servicing the equipment.

1. Relieve pressure in gun and perform gun shutdown procedure. See gun manual.
2. Close gun fluid manifold valves A and B.

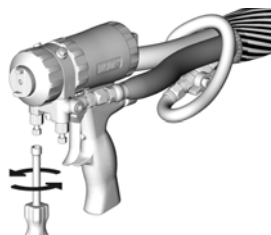

ti2421a

3. Shut off feed pumps and agitator, if used.
4. Turn PRESSURE RELIEF/SPRAY valves (SA, SB)

to PRESSURE RELIEF/CIRCULATION . Route fluid to waste containers or supply tanks. Ensure gauges drop to 0.

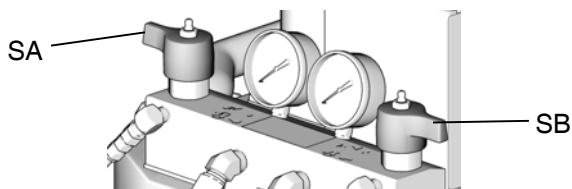

5. Engage gun piston safety lock.



ti2409a

6. Disconnect gun air line and remove gun fluid manifold.

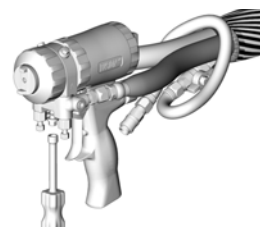

ti2554a

Flush the Equipment



To avoid fire and explosion, always ground equipment and waste container. To avoid static sparking and injury from splashing, always flush at the lowest possible pressure.

Hot solvent may ignite. To avoid fire and explosion:

- Flush equipment only in a well-ventilated area
 - Ensure main power is off and heater is cool before flushing
 - Do not turn on heater until fluid lines are clear of solvent
-
- Flush out old fluid with new fluid, or flush out old fluid with a compatible solvent before introducing new fluid.
 - Use the lowest possible pressure when flushing.
 - All fluid components are compatible with common solvents. Use only moisture-free solvents.

Operation

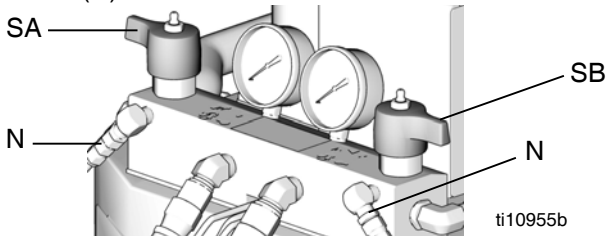

- To flush feed hoses, pumps, and heaters separately from heated hoses, set PRESSURE RELIEF/SPRAY valves (SA, SB) to PRESSURE

RELIEF/CIRCULATION  . Flush through bleed lines (N).



- To flush entire system, circulate through gun fluid manifold (with manifold removed from gun).
- To prevent moisture from reacting with isocyanate, always leave the system dry or filled with a moisture-free plasticizer or oil. Do not use water. See **Moisture Sensitivity of Isocyanates**, page 11.

Startup

				
Do not operate Reactor without all covers and shrouds in place.				

NOTICE

Proper system setup, startup, and shutdown procedures are critical to electrical equipment reliability. The following procedures ensure steady voltage. Failure to follow these procedures will cause voltage fluctuations that can damage electrical equipment and void the warranty.

1. Check generator fuel level.

NOTICE

Running out of fuel will cause voltage fluctuations that can damage electrical equipment.

2. Ensure the main breaker on the generator is in the off position.
3. Start the generator. Allow it to reach full operating temperature.

4. Close the bleed valve on the air compressor.
5. Switch on the air compressor starter and air dryer, if included.
6. Turn on power to the Reactor.

Load fluid with feed pumps



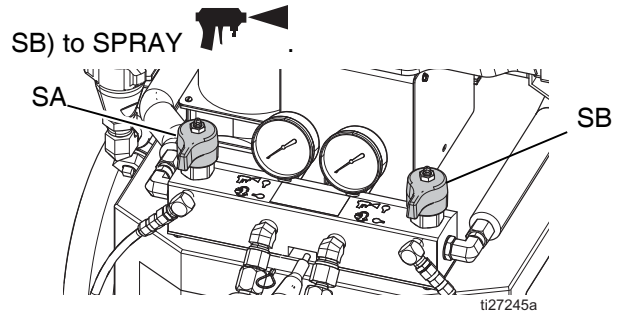

NOTE: The Reactor is tested with oil at the factory. Flush out the oil with a compatible solvent before spraying. See **Flush the Equipment**, page 25.

1. Check that all **Setup** steps are complete.
2. Check that inlet screens are clean before daily startup, see **Fluid Inlet Strainer Screen**, page 35.
3. Check level and condition of ISO lube daily, see **Maintenance**, page 35.
4. Turn on component B agitator, if used.
5. Turn both PRESSURE RELIEF/SPRAY valves (SA,

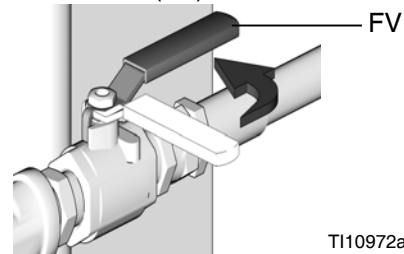

6. Start feed pumps.
7. Open fluid inlet valves (FV). Check for leaks.



				
Do not mix components A and B during startup. Always provide two grounded waste containers to keep component A and component B fluids separate.				

- Use feed pumps to load system. Hold gun fluid manifold over two grounded waste containers. Open fluid valves A and B until clean, air-free fluid comes from valves. Close valves.

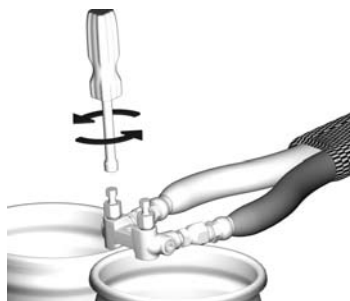

ti2484a

Set temperatures

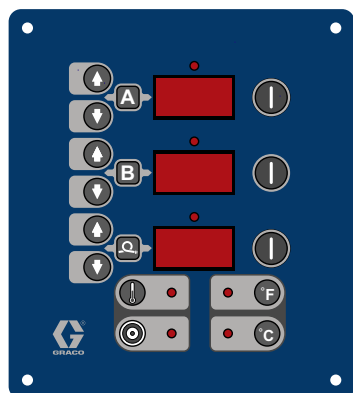

Temperature Controls and Indicators, see page 15

<p>This equipment is used with heated fluid, which can cause equipment surfaces to become very hot. To avoid severe burns:</p> <ul style="list-style-type: none"> Do not touch hot fluid or equipment. Allow equipment to cool completely before touching it. Wear gloves if fluid temperature exceeds 110°F (43°C). 				

- Turn main power ON



- Press **F** or **C** to change temperature scale.

- Press to display target temperatures.
- To set **A** heat zone target temperature, press or until display shows desired temperature. Repeat for **B** and **Q** zones.

NOTE: For **Q** zone only, if FTS is disconnected at startup, display will show hose current (0A). See step 10, page 28.

- Press to display actual temperatures.

<p>Do not turn on hose heat without fluid in hoses.</p>				

- Turn on **Q** heat zone by pressing . Preheat hose (15-60 min). Indicator will flash very slowly when fluid reaches target temperature. Display shows actual fluid temperature in hose near FTS.

<p>Thermal expansion can cause overpressurization, resulting in equipment rupture and serious injury, including fluid injection. Do not pressurize system when preheating hose.</p>				

- Turn on **A** and **B** heat zones by pressing for each zone.
- Hold to view electrical currents for each zone.
- Hold to view heater control circuit board temperature.

10. Manual current control mode only:



When in manual current control mode, monitor hose temperature with thermometer. Install per instructions below. Thermometer reading must not exceed 160°F (71°C). Never leave machine unattended when in manual current control mode.

- a. If FTS is disconnected or display shows diagnostic code E04, turn main power switch



OFF then ON to clear diagnostic code and enter manual current control mode.  display will show current to hose. Current is not limited by target temperature.

- b. Press  or  to adjust current setting.



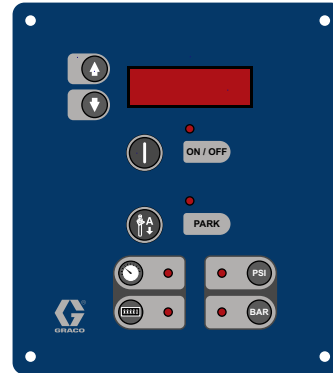

- c. To prevent overheating, install hose thermometer close to gun end, within operator view. Insert thermometer through foam cover of A component hose so stem is next to inner tube. Thermometer reading will be about 20°F less than actual fluid temperature.

- d. If thermometer reading exceeds 160°F (71°C), reduce current with  key.

Set pressure





Motor Controls and Indicators, see page 17

1. Press .
2. Press motor . Motor and pumps start. Display shows system pressure. Motor runs until setpoint is reached.
3. Press  or  until display shows desired fluid pressure. Display will show setpoint for 10 seconds, then change to actual pressure.

NOTE: If display pressure is greater than setpoint pressure, trigger gun to reduce pressure.

NOTE: If display shows J xx, unit is in jog mode. To exit jog mode, see page 33.

4. To display cycle count, press .

NOTE: To clear counter, press  and hold for 3 seconds.

5. Press  or  to change pressure scale.

Change pressure imbalance setting (optional)

The pressure imbalance function (status code 24) detects conditions that can cause off-ratio spray, such as loss of feed pressure/supply, pump seal failure, clogged fluid inlet filter, or a fluid leak.

NOTE: Code 24 (pressure imbalance) is set to an alarm as the default. To change to a warning, see Reactor Repair-Parts manual 312066.

The pressure imbalance default is factory-set at 500 psi (3.5 MPa, 35 bar). For tighter ratio error detection, select a lower value. For looser detection or to avoid nuisance alarms, select a higher value.





1. Turn main power switch OFF .
2. Press and hold **PSI** or **BAR**, then turn main power switch ON . Display will read dP500 for psi or dP_35 for bar.
3. Press  or  to select desired pressure differential (100-999 in increments of 100 psi, or 7-70 in increments of 7 bar). See Table 3.

Table 2 Available Pressure Imbalance Settings

PSI	BAR	PSI	BAR
100	7	600	42
200	14	700	49
300	21	800	56
400	28	900	63
*500	*35	999	69

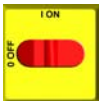
* Factor default setting.

4. Turn main power switch OFF  to save changes.

Spraying



1. Engage gun piston safety lock.



ti2409a

2. Close gun fluid manifold valves A and B.

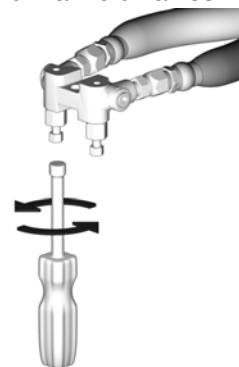

ti2728a

3. Attach gun fluid manifold. Connect gun air line. Open air line valve.

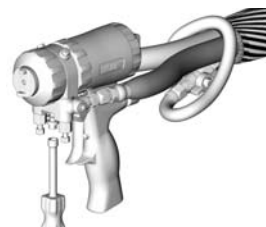

ti2543a

4. Set PRESSURE RELIEF/SPRAY valves (SA, SB) to SPRAY .

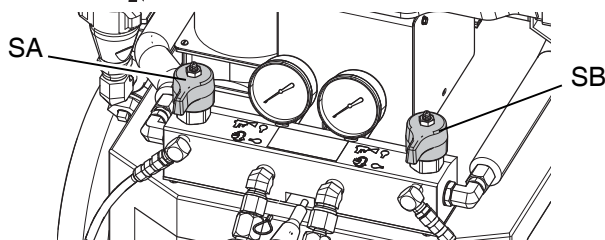

ti27245a

5. Check that heat zones are on and temperatures are on target, see **Set temperatures**, page 27.
6. Press motor  to start motor and pumps.

7. Check fluid pressure display and adjust as necessary, see **Set pressure**, page 28.
8. Check fluid pressure gauges (GA, GB) to ensure proper pressure balance. If imbalanced, reduce pressure of higher component by **slightly** turning PRESSURE RELIEF/SPRAY valve for that component toward PRESSURE

RELIEF/CIRCULATION , until gauges show balanced pressures.

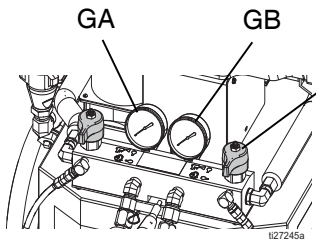

In this example, B side pressure is higher, so use the B side valve to balance pressures.

9. Open gun fluid manifold valves A and B.

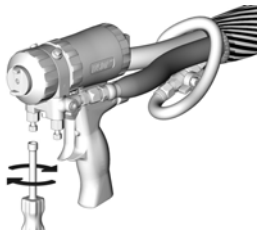

ti2414a

NOTE: On impingement guns, **never** open fluid manifold valves or trigger gun if pressures are imbalanced.

10. Disengage gun piston safety lock.



ti2410a





11. Test spray onto cardboard. Adjust pressure and temperature to get desired results.

12. Equipment is ready to spray.

Shutdown

NOTICE

Proper system setup, startup, and shutdown procedures are critical to electrical equipment reliability. The following procedures ensure steady voltage. Failure to follow these procedures will cause voltage fluctuations that can damage electrical equipment and void the warranty.

1. Shut off , , and  heat zones.
2. Park pumps.
 - a. Press  .
 - b. Trigger gun until pump A stops in the retracted position and the pressure of both pumps bleeds down.

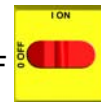

3. Turn main power OFF.
4. Follow the **Pressure Relief Procedure**, page 25.
5. Turn off the air compressor and air dryer, if included.
6. Open air compressor bleed valve to relieve pressure and remove water from tank.
7. Turn off the main breaker on the generator.
8. Allow generator dwell time, per manufacturer recommendations, prior to shutdown.
9. Close both fluid supply valves (FV).

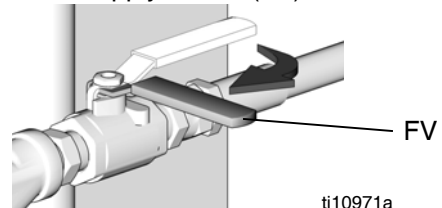

ti10971a

10. Shut down feed pumps as required.

Fluid Circulation

Circulation Through Reactor

Do not circulate fluid containing a blowing agent without consulting with your material supplier regarding fluid temperature limits.				

To circulate through gun manifold and preheat hose, see **Circulation Through Gun Manifold**, page 32.

1. Follow **Operation** procedures, page 25.

Do not install shutoffs downstream of the PRESSURE RELIEF/SPRAY valve outlets (BA, BB). The valves function as overpressure relief valves when set to SPRAY . Lines must be open so valves can automatically relieve pressure when machine is operating.				

2. See **Typical Installation, with circulation**, page 12. Route circulation lines back to respective component A or B supply drum. Use hoses rated at the maximum working pressure of this equipment. See **Technical Specifications**, page 39.
3. Set PRESSURE RELIEF/SPRAY valves (SA, SB) to

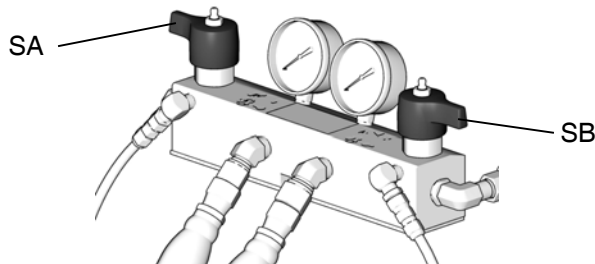

PRESSURE RELIEF/CIRCULATION

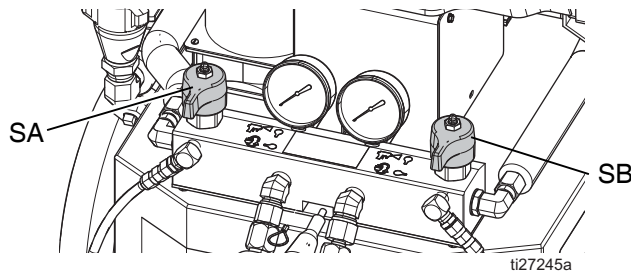

4. Turn main power ON .
5. Set temperature targets see **Set temperatures**, page 27. Turn on **A** and **B** heat zones by pressing . **Do not** turn on heat zone unless hoses are already loaded with fluid.
6. Press to display actual temperatures.
7. Circulate fluid in jog mode until **A** and **B** temperatures reach targets.
8. Turn on heat zone by pressing .
9. Set PRESSURE RELIEF/SPRAY valves (SA, SB) to SPRAY .



Circulation Through Gun Manifold

				
Do not circulate fluid containing a blowing agent without consulting with your material supplier regarding fluid temperature limits.				

Circulating fluid through the gun manifold allows rapid preheating of hose.

1. Install gun fluid manifold (P) on Part 246362 accessory circulation kit (CK). Connect high pressure circulation lines (R) to circulation manifold.

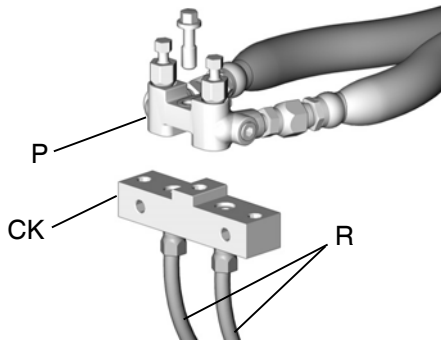

ti2767a

2. Route circulation lines back to respective component A or B supply drum. Use hoses rated at the maximum working pressure of this equipment. See **Typical Installation, without circulation**, page 13.

3. Follow **Operation** procedures, page 25.

4. Turn main power ON .

5. Set temperature targets see **Set temperatures**, page 27. Turn on **A**, **B**, and **P** heat zones by pressing .

6. Press  to display actual temperatures.

7. Circulate fluid in jog mode until **A** and **B** temperatures reach targets.

Jog Mode

Jog mode has two purposes:

- It can speed fluid heating during circulation.
- It can ease pump repair/replacement. See repair manual.

1. Turn main power on

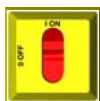

2. Ensure motor  is OFF (LED is off; display may show dashes or pressure).

3. Press  to select J1 (jog speed 1).

4. Press motor  to start motor.

5. Press  or  to change jog speed (J1 through J10).

NOTE: Jog speeds correlate to 3-30% of motor power, but will not operate over 700 psi (4.9 MPa, 49 bar) for either A or B.

6. To exit jog mode, press  until display shows dashes or current pressure.



Diagnostic Codes

Temperature Control Diagnostic Codes

Temperature control diagnostic codes appear on temperature display.

These alarms turn off heat. E99 clears automatically when communication is regained. Codes E03 through

E06 can be cleared by pressing . For other codes,

turn main power OFF  then ON  to clear.

See repair manual for corrective action.

Code	Code Name	Alarm Zone
01	High fluid temperature	Individual
02	High current	Individual
03	No current	Individual
04	FTS not connected	Individual
05	Board overtemperature	Individual
06	Loss of zone communication	Individual
30	Momentary loss of communication	All
99	Loss of display communication	All

NOTE: For hose zone only, if FTS is disconnected at startup, display will show hose current 0A.

Motor Control Diagnostic Codes

Motor control diagnostic codes E21 through E29 appear on pressure display.

There are two types of motor control codes: alarms and warnings. Alarms take priority over warnings.

See repair manual for corrective action.

Alarms

Alarms turn off motor and heat zones. Turn main power

OFF  then ON  to clear.

NOTE: Alarms can also be cleared, except for code 23, by pressing .

Errors

Reactor will continue to run. Press  to clear. An error will not recur for a predetermined amount of time (varies for different warnings), or until main power is

turned OFF  then ON .

Code	Code Name	Alarm or Error
21	No transducer (component A)	Alarm
22	No transducer (component B)	Alarm
23	High pressure	Alarm
24	Pressure imbalance	Selectable; see repair manual
25	High line voltage	Alarm
26	Low line voltage	Alarm
27	High motor temperature	Alarm
28	High current	Alarm
29	Brush wear	Error
30	Momentary loss of communication	-
31	Motor control failure	Alarm
32	Motor control board overtemperature	Alarm
99	Loss of communication	-

Maintenance

- Check wet cup TSL level daily.
- Do not overtighten packing nut/wet cup. Throat u-cup is not adjustable.
- Inspect fluid inlet strainer screens daily, see below.
- Grease circulation valves weekly with Fusion grease (117773).

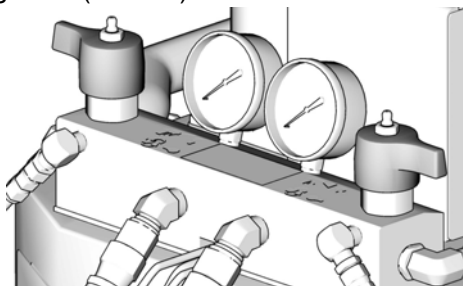

- Inspect ISO lubricant level and condition daily, see page 36. Refill or replace as needed.
- Keep component A from exposure to moisture in atmosphere, to prevent crystallization.
- Clean gun mix chamber ports regularly. See gun manual.
- Clean gun check valve screens regularly. See gun manual.
- Use compressed air to prevent dust buildup on control boards, fan, motor (under shield), and hydraulic oil coolers.
- Keep vent holes on bottom of electrical cabinet open.

Fluid Inlet Strainer Screen



The inlet strainers filter out particles that can plug the pump inlet check valves. Inspect the screens daily as part of the startup routine, and clean as required.

Use clean chemicals and follow proper storage, transfer, and operating procedures, to minimize contamination of the A-side screen.

NOTE: Clean the A-side screen only during daily startup. This minimizes moisture contamination by immediately flushing out any isocyanate residue at the start of dispensing operations.

1. Close the fluid inlet valve at the pump inlet and shut off the appropriate feed pump. This prevents material from being pumped while cleaning the screen.
2. Place a container under the strainer manifold (59d) to catch fluid. Remove the strainer plug (59j).
3. Remove the screen (59g) from the strainer manifold. Thoroughly flush the screen with compatible solvent and shake it dry. Inspect the screen. If more than 25% of the mesh is blocked, replace the screen. Inspect the gasket (59h) and replace as required.
4. Ensure the pipe plug (59k) is screwed into the strainer plug (59j). Install the strainer plug with the screen (59g) and gasket (59h) in place and tighten. Do not overtighten. Let the gasket make the seal.
5. Open the fluid inlet valve, ensure that there are no leaks, and wipe the equipment clean. Proceed with operation.

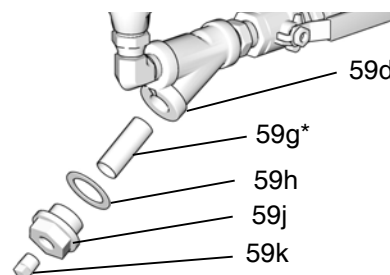

Ti10974a

Fig. 9. Fluid Inlet Strainer

Pump Lubrication System

Check the condition of the ISO pump lubricant daily. Change the lubricant if it becomes a gel, its color darkens, or it becomes diluted with isocyanate.

Gel formation is due to moisture absorption by the pump lubricant. The interval between changes depends on the environment in which the equipment is operating. The pump lubrication system minimizes exposure to moisture, but some contamination is still possible.

Lubricant discoloration is due to continual seepage of small amounts of isocyanate past the pump packings during operation. If the packings are operating properly, lubricant replacement due to discoloration should not be necessary more often than every 3 or 4 weeks.

To change pump lubricant:

1. Follow the **Pressure Relief Procedure**, page 25.
2. Lift the lubricant reservoir (LR) out of the bracket (RB) and remove the container from the cap. Holding the cap over a suitable container, remove the check valve and allow the lubricant to drain. Reattach the check valve to the inlet hose. See FIG. 10.
3. Drain the reservoir and flush it with clean lubricant.
4. When the reservoir is flushed clean, fill with fresh lubricant.
5. Thread the reservoir onto the cap assembly and place it in the bracket.
6. The lubrication system is ready for operation. No priming is required.

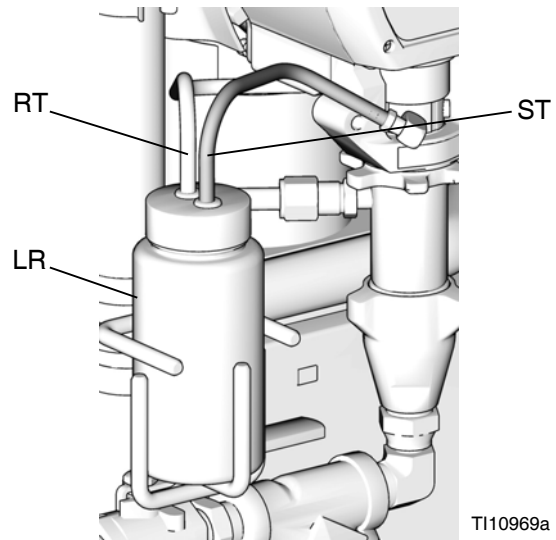
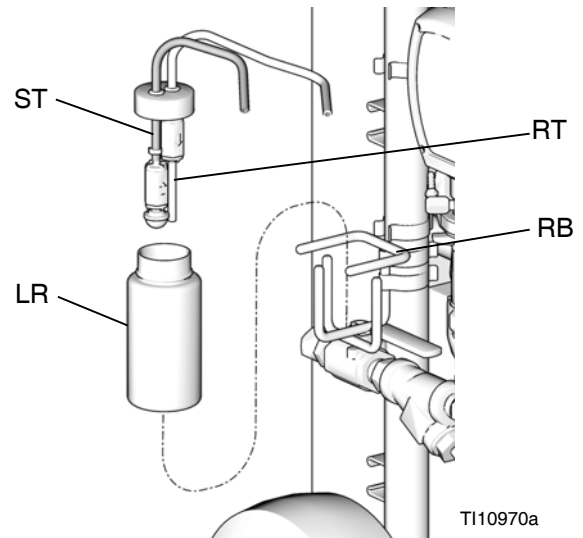

FIG. 10: Pump Lubrication System

Accessories

Feed Pump Kits

Pumps, hoses, and mounting hardware to supply fluids to Reactor. Includes 246483 Air Supply Kit. See 309815.

246483 Air Supply Kit

Hoses and fittings to supply air to feed pumps, agitator, and gun air hose. Included in feed pump kits. See 309827.

246978 Circulation Kit

Return hoses and fittings to make circulation system. Includes two 246477 Return Tube Kits. See 309852.

246477 Return Tube Kit

Desiccant dryer, return tube, and fittings for one drum. Two included in 246978 Circulation Kit. See 309852.

248669 Conversion Kit

Convert any E-XP2 to a E-30 with 15.3kW of heat. Include new pumps, bearing, and fitting to accomplish conversion. See manual 309574.

Heated Hoses

50 ft (15.2 m) and 25 ft (7.6 m) lengths, 1/4 in. (6 mm), 3/8 in. (10 mm), or 1/2 in. (13 mm) diameter, 2000 psi (14 MPa, 140 bar) or 3500 psi (24 MPa, 241 bar). See 309572.

Heated Whip Hoses

10 ft (3 m) whip hose, 1/4 in. (6 mm) or 3/8 in. (10 mm) diameter, 2000 psi (14 MPa, 140 bar) or 3500 psi (24 MPa, 241 bar). See 309572.

Fusion Spray Gun

Air purge gun, available in round or flat pattern. See 309550.

246085 Data Reporting Kit

Records actual temperature, temperature setpoint, actual pressure, cycles, and diagnostic code data from Reactor. Downloads data to PC with Microsoft® Windows 98 or later. See 309867.

248848 Data Reporting Kit

Records actual temperature, temperature setpoint, actual pressure, cycles, and diagnostic code data from Reactor. Downloads data to PC with Microsoft® Windows 98 or later. Does not include interface module. See 309867.

Dimensions

Dimension	in. (mm)
A	46.0 (1168)
B	31.0 (787)
C	33.0 (838)

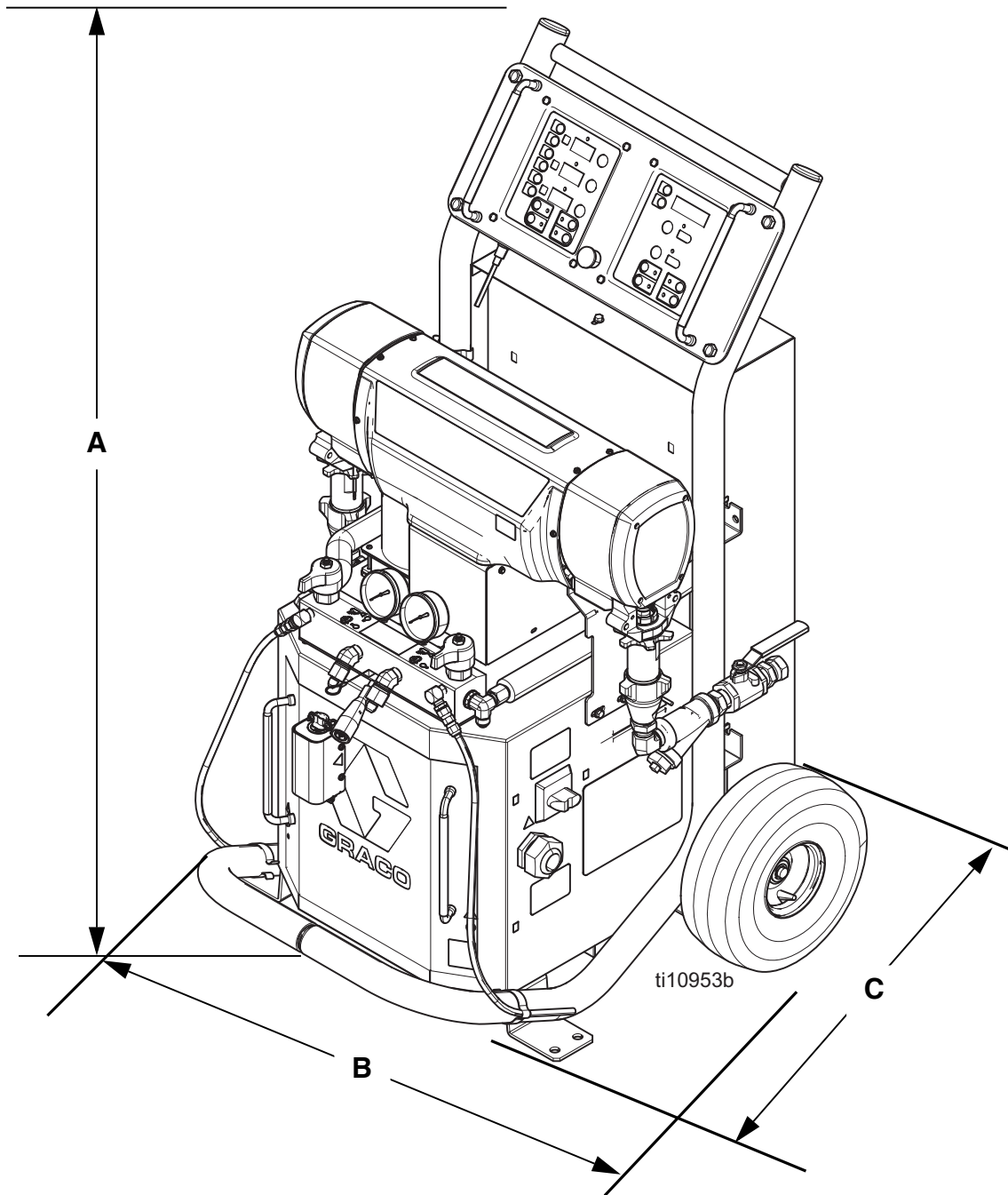

Technical Specifications

Electric Reactor Proportioning System		
	US	Metric
Maximum Fluid Temperature	190°F	88°C
Amperage Requirement	See Table 1, page 19.	
Fluid Inlets	3/4 npt(f), with 3/4 npsm(f) union	
Fluid Circulation Ports	1/4 npsm(m), with plastic tubing; 250 psi (1.75 MPa, 17.5 bar) maximum	
Wetted Parts	Aluminum, stainless steel, zinc plated, carbon steel, brass, carbide, chrome, chemically resistant o-rings, PTFE, ultra-high molecular weight polyethylene	
Maximum fluid working pressure		
Models E-20 and E-30	2000 psi	14 MPa, 140 bar
Model E-XP1	2500 psi	17.2 MPa, 172 bar
Model E-XP2	3500 psi	24.1 MPa, 241 bar
Maximum output		
Model E-20	20 lb/min	9 kg/min
Model E-30	30 lb/min	13.5 kg/min
Model E-XP1	1 gpm	3.8 liter/min
Model E-XP2	2 gpm	7.6 liter/min
Output per cycle (A and B)		
Model E-20 and E-XP1	0.0104 gal	0.0395 liter
Model E-30	0.0272 gal	0.1034 liter
Model E-XP2	0.0203 gal	0.0771 liter
Heater Power		
Model E-20	6000 watts	
Model E-30 and E-XP1	10200 watts	
Models E-XP2 and E-30 with 15.3kW of heat	15300 watts	
Sound Power, per ISO 9614-2		
Model E-20	80 dB(A) at 2000 psi (14 MPa, 140 bar), 0.5 gpm (1.9 lpm)	
Model E-30	93.5 dB(A) at 1000 psi (7 MPa, 70 bar), 3.0 gpm (11.4 lpm)	
Model E-XP1	80 dB(A) at 2000 psi (14 MPa, 140 bar), 0.5 gpm (1.9 lpm)	
Model E-XP2	83.5 dB(A) at 3000 psi (21 MPa, 210 bar), 1.0 gpm (3.8 lpm)	
Sound Pressure, 1 m from equipment		
Model E-20	70.2 dB(A) at 2000 psi (14 MPa, 140 bar), 0.5 gpm (1.9 lpm)	
Model E-30	83.6 dB(A) at 1000 psi (7 MPa, 70 bar), 3.0 gpm (11.4 lpm)	
Model E-XP1	70.2 dB(A) at 2000 psi (14 MPa, 140 bar), 0.5 gpm (1.9 lpm)	
Model E-XP2	73.6 dB(A) at 3000 psi (21 MPa, 210 bar), 1.0 gpm (3.8 lpm)	
Fluid Outlets		
Component A (ISO)	#8 (1/2 in.) JIC, with #5 (5/16 in.) JIC adapter	
Component B (RES)	#10 (5/8 in.) JIC, with #6 (3/8 in.) JIC adapter	
Weight		
Model E-20 and E-XP1	342 lb	155 kg
Model E-30	400 lb	181kg
Models E-XP2 and E-30 with 15.3kW of heat:	438 lb	198 kg

Electric Reactor Proportioning System		
	US	Metric
Voltage Tolerance Range (50/60 Hz)		
200-240 V ac Nominal, 1-Phase	195-264 V ac	50/60 Hz
200-240 V ac Nominal, 3-Phase Delta	195-264 V ac	50/60 Hz
350-415 V ac Nominal, 3-Phase Wye (200-240 V ac Line-to-Neutral)	338-457 V ac	50/60 Hz
Notes		
All trademarks or registered trademarks are the property of their respective owners.		

California Proposition 65

CALIFORNIA RESIDENTS

 **WARNING:** Cancer and reproductive harm – www.P65warnings.ca.gov.

Graco Standard Warranty

Graco warrants all equipment referenced in this document which is manufactured by Graco and bearing its name to be free from defects in material and workmanship on the date of sale to the original purchaser for use. With the exception of any special, extended, or limited warranty published by Graco, Graco will, for a period of twelve months from the date of sale, repair or replace any part of the equipment determined by Graco to be defective. This warranty applies only when the equipment is installed, operated and maintained in accordance with Graco's written recommendations.

This warranty does not cover, and Graco shall not be liable for general wear and tear, or any malfunction, damage or wear caused by faulty installation, misapplication, abrasion, corrosion, inadequate or improper maintenance, negligence, accident, tampering, or substitution of non-Graco component parts. Nor shall Graco be liable for malfunction, damage or wear caused by the incompatibility of Graco equipment with structures, accessories, equipment or materials not supplied by Graco, or the improper design, manufacture, installation, operation or maintenance of structures, accessories, equipment or materials not supplied by Graco.

This warranty is conditioned upon the prepaid return of the equipment claimed to be defective to an authorized Graco distributor for verification of the claimed defect. If the claimed defect is verified, Graco will repair or replace free of charge any defective parts. The equipment will be returned to the original purchaser transportation prepaid. If inspection of the equipment does not disclose any defect in material or workmanship, repairs will be made at a reasonable charge, which charges may include the costs of parts, labor, and transportation.

THIS WARRANTY IS EXCLUSIVE, AND IS IN LIEU OF ANY OTHER WARRANTIES, EXPRESS OR IMPLIED, INCLUDING BUT NOT LIMITED TO WARRANTY OF MERCHANTABILITY OR WARRANTY OF FITNESS FOR A PARTICULAR PURPOSE.

Graco's sole obligation and buyer's sole remedy for any breach of warranty shall be as set forth above. The buyer agrees that no other remedy (including, but not limited to, incidental or consequential damages for lost profits, lost sales, injury to person or property, or any other incidental or consequential loss) shall be available. Any action for breach of warranty must be brought within two (2) years of the date of sale.

GRACO MAKES NO WARRANTY, AND DISCLAIMS ALL IMPLIED WARRANTIES OF MERCHANTABILITY AND FITNESS FOR A PARTICULAR PURPOSE, IN CONNECTION WITH ACCESSORIES, EQUIPMENT, MATERIALS OR COMPONENTS SOLD BUT NOT MANUFACTURED BY GRACO. These items sold, but not manufactured by Graco (such as electric motors, switches, hose, etc.), are subject to the warranty, if any, of their manufacturer. Graco will provide purchaser with reasonable assistance in making any claim for breach of these warranties.

In no event will Graco be liable for indirect, incidental, special or consequential damages resulting from Graco supplying equipment hereunder, or the furnishing, performance, or use of any products or other goods sold hereto, whether due to a breach of contract, breach of warranty, the negligence of Graco, or otherwise.

FOR GRACO CANADA CUSTOMERS

The Parties acknowledge that they have required that the present document, as well as all documents, notices and legal proceedings entered into, given or instituted pursuant hereto or relating directly or indirectly hereto, be drawn up in English. Les parties reconnaissent avoir convenu que la rédaction du présente document sera en Anglais, ainsi que tous documents, avis et procédures judiciaires exécutés, donnés ou intentés, à la suite de ou en rapport, directement ou indirectement, avec les procédures concernées.

Graco Information

For the latest information about Graco products, visit www.graco.com.

For patent information, see www.graco.com/patents.

TO PLACE AN ORDER, contact your Graco distributor or call to identify the nearest distributor.

Phone: 612-623-6921 or Toll Free: 1-800-328-0211, Fax: 612-378-3505

*All written and visual data contained in this document reflects the latest product information available at the time of publication.
Graco reserves the right to make changes at any time without notice.*

Original instructions. This manual contains English. MM

Graco Headquarters: Minneapolis

International Offices: Belgium, China, Japan, Korea

**GRACO INC. AND SUBSIDIARIES • P.O. BOX 1441 • MINNEAPOLIS MN 55440-1441 • USA
Copyright 2020, Graco Inc. All Graco manufacturing locations are registered to ISO 9001.**

www.graco.com
Revision V, June 2020