

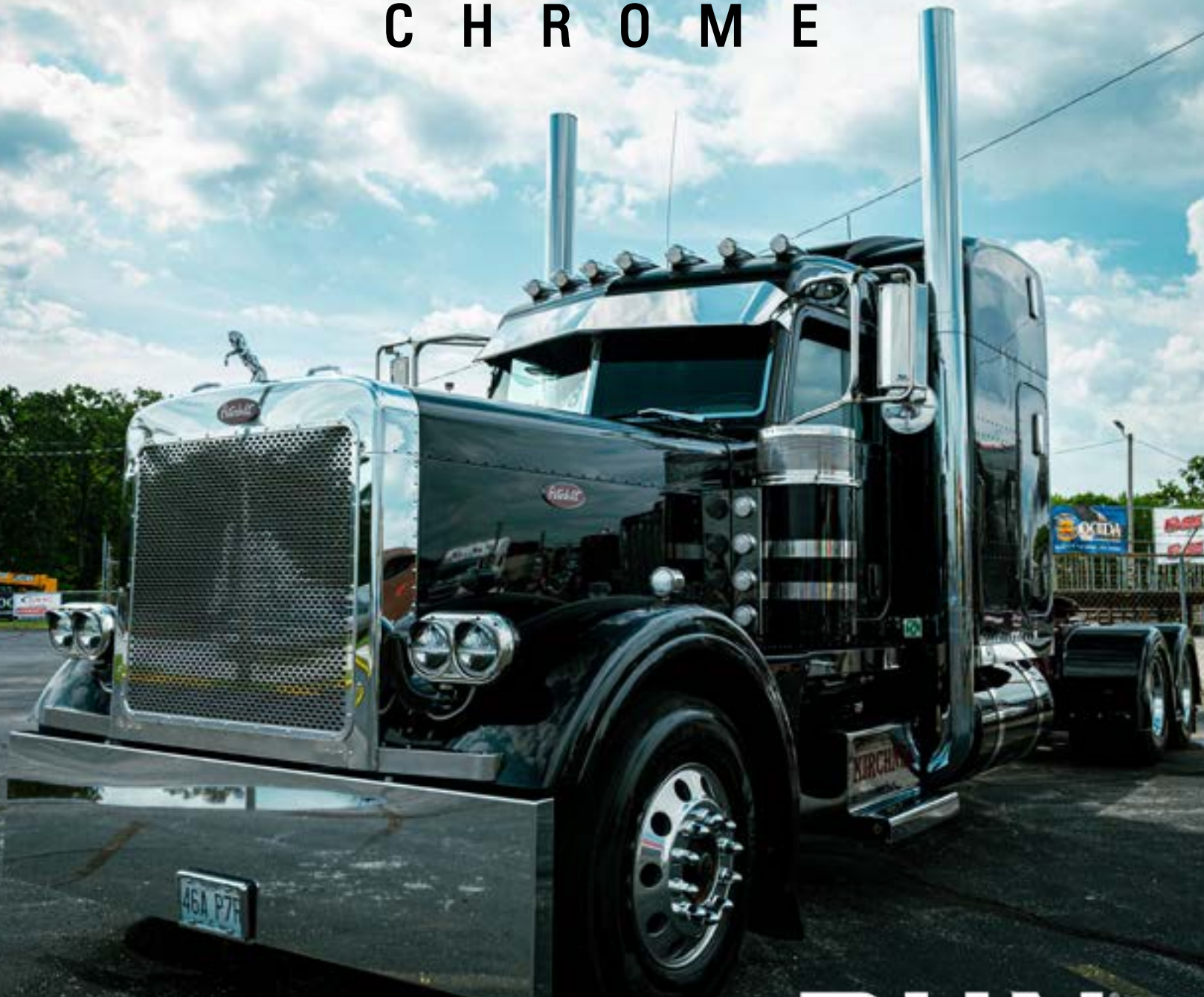

LINCOLN

C H R O M E



PRODUCT CATALOG VOL 6

TWO YEAR PRODUCT WARRANTY

888.966.6609 • LINCOLNCHROME.COM • MADE IN LINCOLN, NEBRASKA

RUN
AMERICAN



TABLE OF CONTENTS



GRILLES:
Available for
• Peterbilt 389, 589
• Kenworth W900L
Page 64

VISORS:
Available in
• Bowtie
• Reverse Bowtie
• Forward Bowtie
• Straight
Page 58

EXHAUST KITS:
Available for
• Peterbilt 359,
379, 389, 589
• Kenworth W900L,
W9008, W900A, T800
• Freightliner
Classic, FLD120, Coro-
nado
• Western Star Constella-
tion Cab, 4900 Heritage
Page 6

**CHROME PLATED
BUMPERS:**
Available in
• 10GA Carbon Steel
• 11GA Stainless steel
Page 40

ACCESSORIES
Page 60

Peterbilt Exhaust Kits8
 Height Guide17
 Kenworth Exhaust kits18
 Freightliner Exhaust kits23
 Fitment Guide for Non-Kit Exhaust kits24
 Exhaust Components.....27
 Top Styles/End Forms31
 Stacks | 5 inch-8 inch32
 Elbows.....34
 Spools & Y-Pipes.....37
 Clamps38
 Brackets, Bushings, Adapters39
 Bumpers40
 Bumper Styles42
 Peterbilt 389 & 589 Bumpers43
 Peterbilt 379 Bumpers44
 Peterbilt 359 Bumpers45
 Kenworth W900 Bumpers47
 Freightliner Classic Bumpers49
 Western Star Bumpers52
 Visors.....58
 Chrome Plated & Stainless Steel Accessories60
 Mudflap Weights.....65
 Thank You.....67
 General Information69



WE'VE ALWAYS BEEN TOLD, "I RUN LINCOLN CHROME EXHAUST BECAUSE THEY LAST THE LONGEST" — HERE'S THE SCIENCE THAT PROVES IT.



Long-Lasting Quality Nickel Chrome Plating Contains 3 Layers of Nickel:

- Semi-Bright Nickel
- Bright Nickel
- Microporous Nickel (functional layer of nickel for protection)



COMPETITOR X



TRUSTED BY THE BEST.
70+ YEARS OF CHROME PLATING.
LOOKS GREAT. LASTS LONGER.
SUPERIOR CUSTOMER SERVICE.
MADE IN AMERICA.

- ✓ Lincoln Chrome Plating: **More than 3X the nickel**
- ✓ Correct Ratio of Semi-Bright & Bright Nickel offers superior **corrosion resistance**
- ✓ **Layer of microporous nickel to protect the base material**
- ✓ **Meets rigorous OEM requirements**

- ✗ Competitor Plating: **Imbalanced nickel layers.** Too little semi bright, too much bright nickel = poor corrosion protection
- ✗ **Too much bright nickel layer** boosts shine but **cuts durability**
- ✗ Missing microporous nickel leaves the product **vulnerable to corrosion**



- TRUSTED BY THE BEST
- 70+ YEARS OF CHROME PLATING
- LOOKS GREAT, LASTS LONGER
- SUPERIOR CUSTOMER SERVICE
- MADE IN AMERICA



EXHAUST KITS

PETERBILT 589 389 379 359 **KENWORTH** W900L W900B W900A T800
FREIGHTLINER CLASSIC FLD120 CORONADO **WESTERN STAR** CONSTELLATION CAB 4900 HERITAGE



AVAILABLE IN 5" 6" 7" OR 8" DIAMETER
 24"-120" TOP STACKS

DUMMY EXHAUST KITS

Peterbilt 8" Dummy Kit

PETE8		
Part Number	Description	Quantity
L9008-E29-A24-1103	8" 90 Degree Elbow	2
14-022998	Angled Bracket	2
50-02083	8" Angled Clamp	4
50-01083	Staight PB Clamp	2
14-062998	Y Pipe Support Bracket	2
14-BU4656	Package of 8 Bushings	1
1000142	Silicone	1

Peterbilt 7" Dummy Kit

PETE7		
Part Number	Description	Quantity
L9007-E29-A24-1103	7" 90 Degree Elbow	2
14-022998	Angled Bracket	2
50-02073	7" Angled Clamp	4
50-01073	Staight PB Clamp	2
14-062998	Y Pipe Support Bracket	2
14-BU4656	Package of 8 Bushings	1
1000142	Silicone	1

Peterbilt 6" Dummy Kit

PETE6		
Part Number	Description	Quantity
L9006-E29-A24-1103	6" 90 Degree Elbow	2
14-022998	Angled Bracket	2
50-02063	6" Angled Clamp	4
50-01063	Staight PB Clamp	2
14-062998	Y Pipe Support Bracket	2
14-BU4656	Package of 8 Bushings	1
1000142	Silicone	1

Peterbilt 5" Dummy Kit

PETE5		
Part Number	Description	Quantity
L9005-E29-A24-1103	5" 90 Degree Elbow	2
14-022998	Angled Bracket	2
50-02053	5" Angled Clamp	4
50-01053	Staight PB Clamp	2
14-062998	Y Pipe Support Bracket	2
14-BU4656	Package of 8 Bushings	1
1000142	Silicone	1





PETERBILT 589 EXHAUST KITS

PETERBILT 589 EXHAUST KITS

P589-5-1		
5" Factory Side Exhaust Kit - Sleeper		
Part Number	Description	Quantity
L9005-E29-A24-1103	5" 90 Degree Elbow	2
50-04053	5" Slider Clamp	2
50-00053	5" Bracketless Clamp	2
405E-014-1103	Undercab Spool	1
50-09053	5" Band Clamps	2
1000240-3	Sleeper Cab Bracket Adapter	2
14-072998	589 Elbow Support - Side Exh	2
50-01053	5" Straight Clamp	2
1000142	Silicone	1
HTS4100-500X36	5" Flex Pipe	1

P589-5-3		
5" Factory Side Exhaust Kit - Day Cab		
Part Number	Description	Quantity
L9005-E29-A24-1103	5" 90 Degree Elbow	2
50-04053	5" Slider Clamp	2
50-00053	5" Bracketless Clamp	2
405E-014-1103	Undercab Spool	1
50-09053	5" Band Clamps	2
1000241-3	Day Cab Bracket Adapter	2
14-072998	589 Elbow Support - Side Exh	2
50-01053	5" Straight Clamp	2
1000142	Silicone	1
HTS4100-500X36	5" Flex Pipe	1

P589-5-2		
5" Weed Burner (Dummy Exhaust) Kit - Sleeper		
Part Number	Description	Quantity
L9005-E29-A24-1103	5" 90 Degree Elbow	2
50-04053	5" Slider Clamp	2
50-00053	5" Bracketless Clamp	2
1000240-3	Cab Bracket Adapter	2
14-082998-2	589 Frame Mount Support Bracket	2
50-01053	5" Straight Clamp	2
1000142	Silicone	1

P589-5-4		
5" Weed Burner (Dummy Exhaust) Kit - Day Cab		
Part Number	Description	Quantity
L9005-E29-A24-1103	5" 90 Degree Elbow	2
50-04053	5" Slider Clamp	2
50-00053	5" Bracketless Clamp	2
1000241-3	Day Cab Bracket Adapter	2
14-082998-2	589 Frame Mount Support Bracket	2
50-01053	5" Straight Clamp	2
1000142	Silicone	1

P589-6-1		
6" Factory Side Exhaust Kit - Sleeper		
Part Number	Description	Quantity
L9006-E29-B20-1103	6"-5" 90 Degree Elbow	2
50-04063	6" Slider Clamp	2
50-00063	6" Bracketless Clamp	2
405E-014-1103	Undercab Spool	2
50-09053	5" Band Clamps	2
1000240-3	Sleeper Cab Bracket Adapter	2
14-072998	589 Elbow Support - Side Exh	2
50-01063	6" Straight Clamp	2
1000142	Silicone	1

P589-6-3		
6" Factory Side Exhaust Kit - Day Cab		
Part Number	Description	Quantity
L9006-E29-B20-1103	6"-5" 90 Degree Elbow	2
50-04063	6" Slider Clamp	2
50-00063	6" Bracketless Clamp	2
405E-014-1103	Undercab Spool	2
50-09053	5" Band Clamps	2
1000241-3	Day Cab Bracket Adapter	2
14-072998	589 Elbow Support - Side Exh	2
50-01063	6" Straight Clamp	2
1000142	Silicone	1

P589-6-2		
6" Weed Burner (Dummy Exhaust) Kit - Sleeper		
Part Number	Description	Quantity
L9006-E29-A24-1103	6" 90 Degree Elbow	2
50-04063	6" Slider Clamp	2
50-00063	6" Bracketless Clamp	2
1000240-3	Cab Bracket Adapter	2
14-082998-2	589 Frame Mount Support Bracket	2
50-01063	6" Straight Clamp	2
1000142	Silicone	1

P589-6-4		
6" Weed Burner (Dummy Exhaust) Kit - Day Cab		
Part Number	Description	Quantity
L9006-E29-A24-1103	6" 90 Degree Elbow	2
50-04063	6" Slider Clamp	2
50-00063	6" Bracketless Clamp	2
1000241-3	Day Cab Bracket Adapter	2
14-082998-2	589 Frame Mount Support Bracket	2
50-01063	6" Straight Clamp	2
1000142	Silicone	1

P589-7-1		
7" Factory Side Exhaust Kit - Sleeper		
Part Number	Description	Quantity
L9007-E29-B20-1103	7"-5" 90 Degree Elbow	2
50-08073	7" Slider Clamp	2
50-00073	7" Bracketless Clamp	2
405E-014-1103	5" Undercab Spool	2
50-09053	5" Band Clamp	2
1000240-3	Sleeper Cab Bracket Adapter	2
14-072998	589 Elbow Support - Side Exh	2
1000242	Slider Pin & Hardware	2
50-01073	7" Straight Clamp	2
1000142	Silicone	1

P589-7-3		
7" Factory Side Exhaust Kit - Day Cab		
Part Number	Description	Quantity
L9007-E29-B20-1103	7"-5" 90 Degree Elbow	2
50-08073	7" Slider Clamp	2
50-00073	7" Bracketless Clamp	2
405E-014-1103	5" Undercab Spool	2
50-09053	5" Band Clamp	2
1000241-3	Day Cab Bracket Adapter	2
14-072998	589 Elbow Support - Side Exh	2
1000242	Slider Pin & Hardware	2
50-01073	7" Straight Clamp	2
1000142	Silicone	1

P589-7-2		
7" Weed Burner (Dummy Exhaust) Kit - Sleeper		
Part Number	Description	Quantity
L9007-E29-A24-1103	7" 90 Degree Elbow	2
50-08073	7" Slider Clamp	2
50-00073	7" Bracketless Clamp	2
50-09053	5" Band Clamp	2
1000240-3	Sleeper Cab Bracket Adapter	2
14-082998-2	589 Elbow Support - WB	2
1000242	Slider Pin & Hardware	2
50-01073	7" Straight Clamp	2
1000142	Silicone	1

P589-7-4		
7" Weed Burner (Dummy Exhaust) Kit - Day Cab		
Part Number	Description	Quantity
L9007-E29-A24-1103	7" 90 Degree Elbow	2
50-08073	7" Slider Clamp	2
50-00073	7" Bracketless Clamp	2
50-09053	5" Band Clamp	2
1000241-3	Day Cab Bracket Adapter	2
14-082998-2	589 Elbow Support - WB	2
1000242	Slider Pin & Hardware	2
50-01073	7" Straight Clamp	2
1000142	Silicone	1

P589-8-1		
8" Factory Side Exhaust Kit - Sleeper		
Part Number	Description	Quantity
L9008-E29-B20-1103	8"-5" 90 Degree Elbow	2
50-08083	8" Slider Clamp	2
50-00083	8" Bracketless Clamp	2
405E-014-1103	5" Undercab Spool	2
50-09053	5" Band Clamp	2
1000240-3	Sleeper Cab Bracket Adapter	2
14-072998	589 Elbow Support - Side Exh	2
1000242	Slider Pin & Hardware	2
50-01083	8" Straight Clamp	2
1000142	Silicone	1

P589-8-3		
8" Factory Side Exhaust Kit - Day Cab		
Part Number	Description	Quantity
L9008-E29-B20-1103	8"-5" 90 Degree Elbow	2
50-08083	8" Slider Clamp	2
50-00083	8" Bracketless Clamp	2
405E-014-1103	5" Undercab Spool	2
50-09053	5" Band Clamp	2
1000241-3	Day Cab Bracket Adapter	2
14-072998	589 Elbow Support - Side Exh	2
1000242	Slider Pin & Hardware	2
50-01083	8" Straight Clamp	2
1000142	Silicone	1

P589-8-2		
8" Weed Burner (Dummy Exhaust) Kit - Sleeper		
Part Number	Description	Quantity
L9008-E29-A24-1103	8" 90 Degree Elbow	2
50-08083	8" Slider Clamp	2
50-00083	8" Bracketless Clamp	2
50-09053	5" Band Clamp	2
1000240-3	Sleeper Cab Bracket Adapter	2
14-082998-2	589 Elbow Support - WB	2
1000242	Slider Pin & Hardware	2
50-01083	8" Straight Clamp	2
1000142	Silicone	1

P589-8-4		
8" Weed Burner (Dummy Exhaust) Kit - Day Cab		
Part Number	Description	Quantity
L9008-E29-A24-1103	8" 90 Degree Elbow	2
50-08083	8" Slider Clamp	2
50-00083	8" Bracketless Clamp	2
50-09053	5" Band Clamp	2
1000241-3	Day Cab Bracket Adapter	2
14-082998-2	589 Elbow Support - WB	2
1000242	Slider Pin & Hardware	2
50-01083	8" Straight Clamp	2
1000142	Silicone	1





PETERBILT 389 SIDE EXHAUST KITS

PETERBILT 389 SIDE EXHAUST KITS

P389-8-4 (2018+)		
Full Diameter 8" DPF Shift Kit - Chrome Plated Steel		
Part Number	Description	Quantity
Y9008-E48-B15-1103	Large Diameter Y Pipe	1
L9008-E29-A24-1103	90 Degree Elbow LD	2
50-09053	5" Band Clamp	4
50-02083	Angled PB Clamp	4
50-01083	Staight PB Clamp	2
14-BU4656	Package of 8 Bushings	1
14-022998	Angled Cab Bracket	2
14-062998	Y Pipe Support Bracket	2
1000220	DPF Shift Bracket Assembly	2
1000217	DPF Shift Inlet Elbow	1
1000228	DPF Shift Outlet Elbow 1	1
1000072	DPF Shift Outlet Elbow 2	1
1000142	5" Marman Seal	1

P389-8- 5 (2018+)		
8" -5" DPF Shift Kit - Chrome Plated Steel		
Part Number	Description	Quantity
Y9005-E60-A16-1103	Large 5" Diameter Y Pipe	1
L9008-E29-B20-1103	7"-5" 90 Degree Elbow LD	2
50-09053	5" Band Clamp	4
50-02083	Angled PB Clamp	4
50-01053	Staight PB Clamp	2
14-BU4656	Package of 8 Bushings	1
14-022998	Angled Cab Bracket	2
14-062998	Y Pipe Support Bracket	2
1000220	DPF Shift Bracket Assembly	2
1000217	DPF Shift Inlet Elbow	1
1000228	DPF Shift Outlet Elbow 1	1
1000229	DPF Shift Outlet Elbow 2	1
1000142	Silicone	1

P389-7-4 (2018+)		
Full Diameter 7" DPF Shift Kit - Chrome Plated Steel		
Part Number	Description	Quantity
Y9007-E48-B15-1103	Large Diameter Y Pipe	1
L9007-E29-A24-1103	90 Degree Elbow LD	2
50-09053	5" Band Clamp	4
50-02073	Angled PB Clamp	4
50-01073	Staight PB Clamp	2
14-BU4656	Package of 8 Bushings	1
14-022998	Angled Cab Bracket	2
14-062998	Y Pipe Support Bracket	2
1000220	DPF Shift Bracket Assembly	2
1000217	DPF Shift Inlet Elbow	1
1000228	DPF Shift Outlet Elbow 1	1
1000072	DPF Shift Outlet Elbow 2	1
1000142	5" Marman Seal	1

P389-7- 5 (2018+)		
7" -5" DPF Shift Kit - Chrome Plated Steel		
Part Number	Description	Quantity
Y9005-E60-A16-1103	Large 5" Diameter Y Pipe	1
L9007-E29-B20-1103	7"-5" 90 Degree Elbow LD	2
50-09053	5" Band Clamp	4
50-02073	Angled PB Clamp	4
50-01053	Staight PB Clamp	2
14-BU4656	Package of 8 Bushings	1
14-022998	Angled Cab Bracket	2
14-062998	Y Pipe Support Bracket	2
1000220	DPF Shift Bracket Assembly	2
1000217	DPF Shift Inlet Elbow	1
1000228	DPF Shift Outlet Elbow 1	1
1000229	DPF Shift Outlet Elbow 2	1
1000142	Silicone	1





PETERBILT 389 SIDE EXHAUST KITS

PETERBILT 389 SIDE EXHAUST KITS

P389-6- 4 (2018+)		
Full Diameter 6" DPF Shift Kit - Chrome Plated Steel		
Part Number	Description	Quantity
Y9006-E48-B15-1103	Large 6" Diameter Y Pipe	1
L9006-E29-A24-1103	6" 90 Degree Elbow LD	2
50-09053	5" Band Clamp	4
50-02063	Angled PB Clamp	4
50-01063	Staight PB Clamp	2
14-BU4656	Package of 8 Bushings	1
14-022998	Angled Cab Bracket	2
14-062998	Y Pipe Support Bracket	2
1000220	DPF Shift Bracket Assembly	2
1000217	DPF Shift Inlet Elbow	1
1000228	DPF Shift Outlet Elbow 1	1
1000229	DPF Shift Outlet Elbow 2	1
1000142	Silicone	1

P389-6- 5 (2018+)		
6"-5" DPF Shift Kit - Chrome Plated Steel		
Part Number	Description	Quantity
Y9005-E60-A16-1103	Large 5" Diameter Y Pipe	1
L9006-E29-B20-1103	6"-5" 90 Degree Elbow LD	2
50-09053	5" Band Clamp	4
50-02063	Angled PB Clamp	4
50-01053	Staight PB Clamp	2
14-BU4656	Package of 8 Bushings	1
14-022998	Angled Cab Bracket	2
14-062998	Y Pipe Support Bracket	2
1000220	DPF Shift Bracket Assembly	2
1000217	DPF Shift Inlet Elbow	1
1000228	DPF Shift Outlet Elbow 1	1
1000229	DPF Shift Outlet Elbow 2	1
1000142	Silicone	1

P389-5- 4 (2018+)		
5" DPF Kit - Chrome Plated Steel		
Part Number	Description	Quantity
Y9005-E60-A16-1103	Large 5" Diameter Y Pipe	1
L9005-E29-A24-1103	5" 90 Degree Elbow LD	2
50-02053	Angled PB Clamp	4
50-01053	Staight PB Clamp	2
14-BU4656	Package of 8 Bushings	1
14-022998	Angled Cab Bracket	2
14-062998	Y Pipe Support Bracket	2
1000142	Silicone	1

P389-7-3 (2018+)		
Full Diameter 7" Peterbilt 389 with DPF Chrome Plated Stainless Steel Exhaust kit		
Part Number	Description	Quantity
Y9007-E42-B11-2103	Large Diameter SS Y Pipe	1
L9007-E29-A24-2103	7" 90 Degree SS Elbow	2
50-09053	5" Band Clamp	4
50-02073	Angled PB Clamp	4
50-01073	Straight PB Clamp	2
14-BU4656	Package of 8 Bushings	1
14-022998	Angled Cab Bracket	2
14-062998	Y Pipe Support Bracket	2
1000220	DPF Shift Bracket Assembly	1
1000217	DPF Shift Inlet Elbow	1
1000228	DPF Shift Outlet Elbow 1	1
1000229	DPF Shift Outlet Elbow 2	1
1000142	Silicone	1





PETERBILT 389 SIDE EXHAUST KITS

PETERBILT 379 EXHAUST- 2 PIECE KITS

P389-7 (2011-2017)		
Full Diameter 7" Peterbilt 389 with DPF Stainless Steel Exhaust kit		
Part Number	Description	Quantity
Y9007-E42-B11-2103	Large Diameter SS Y Pipe	1
L9007-E29-A24-2103	7" 90 Degree SS Elbow	2
50-09053	5" Band Clamp	1
50-02073	Angled Clamp	4
14-BU4656	Package of 8 Bushings	1
14-022998	Angled Bracket	2
14-062998	Y Pipe Support Bracket	2
50-01073	Straight Clamp	2
1000077	Shift Bracket, Rear	1
1000076	Shift Bracket, Front	1
1000073	4" to 5" DPF Elbow	1
1000072	5" DPF to Y Pipe	1
1000069	5" Marman Seal	2
1000068	4" Marman Seal	1



P379-7-01		
2 Piece Stack 7" Exhaust Package for Pre-2003 Peterbilt 379 with Large Diameter Y Pipe		
Part Number	Description	Quantity
Y9007-E48-B15-1103	Large Diameter Y Pipe	1
L9007-E29-A24-1103	90 Degree Elbow LD	2
50-09053	5" Band Clamp	1
50-02073	Angled Clamp	4
50-00073	Bracketless Clamp	2
407E-052-1103	52" Spool	2
14-BU4656	Package of 8 Bushings	1
14-022998	Angled Bracket	2
1000142	Silicone	1

P379-7-02		
2 Piece Stack 7" Exhaust Package for Pre-2003 Peterbilt 379 Reduced to 5 Y Pipe		
Part Number	Description	Quantity
Y9005-A24-A15-1103	5" Y Pipe	1
L9007-E29-B20-1103	90 Degree Elbow RDC 5"	2
50-09053	5" Band Clamp	4
50-02073	Angled Clamp	4
407E-052-1103	52" Spool	2
14-BU4656	Package of 8 Bushings	1
14-022998	Angled Bracket	2
1000142	Silicone	1

P379-7-03		
2 Piece Stack 7" Exhaust Package for Post-2003 Peterbilt 379 with Large Diameter Y Pipe		
Part Number	Description	Quantity
Y9007-E48-B15-1103	Large Diameter Y Pipe	1
L9007-E29-A24-1103	90 Degree Elbow LD	2
50-09053	5" Band Clamp	1
50-02073	Angled Clamp	4
50-00073	Bracketless Clamp	2
407E-055-1103	55" Spool	2
14-BU4656	Package of 8 Bushings	1
14-022998	Angled Bracket	2
1000142	Silicone	1

P379-7-04		
2 Piece Stack 7" Exhaust Package for Post-2003 Peterbilt 379 Reduced to 5 Y Pipe		
Part Number	Description	Quantity
Y9005-A24-A15-1103	5" Y Pipe	1
L9007-E29-B20-1103	90 Degree Elbow RDC 5"	2
50-09053	5" Band Clamp	4
50-02073	Angled Clamp	4
407E-055-1103	55" Spool	2
14-BU4656	Package of 8 Bushings	1
14-022998	Angled Bracket	2
1000142	Silicone	1

P379-8-01		
2 Piece Stack 8" Exhaust Package for Pre-2003 Peterbilt 379 with Large Diameter Y Pipe		
Part Number	Description	Quantity
Y9008-E48-B15-1103	Large Diameter Y Pipe	1
L9008-E29-A24-1103	90 Degree Elbow LD	2
50-09053	5" Band Clamp	1
50-02083	Angled Clamp	4
50-00083	Bracketless Clamp	2
408E-052-1103	52" Spool	2
14-BU4656	Package of 8 Bushings	1
14-022998	Angled Bracket	2
1000142	Silicone	1

P379-8-02		
2 Piece Stack 8" Exhaust Package for Pre-2003 Peterbilt 379 Reduced to 5 Y Pipe		
Part Number	Description	Quantity
Y9005-A24-A15-1103	5" Y Pipe	1
L9008-E29-B20-1103	90 Degree Elbow RDC 5"	2
50-09053	5" Band Clamp	4
50-02083	Angled Clamp	4
408E-052-1103	52" Spool	2
14-BU4656	Package of 8 Bushings	1
14-022998	Angled Bracket	2
1000142	Silicone	1

P379-8-03		
2 Piece Stack 8" Exhaust Package for Post-2003 Peterbilt 379 with Large Diameter Y Pipe		
Part Number	Description	Quantity
Y9008-E48-B15-1103	Large Diameter Y Pipe	1
L9008-E29-A24-1103	90 Degree Elbow LD	2
50-09053	5" Band Clamp	1
50-02083	Angled Clamp	4
50-00083	Bracketless Clamp	2
408E-055-1103	55" Spool	2
14-BU4656	Package of 8 Bushings	1
14-022998	Angled Bracket	2
1000142	Silicone	1

P379-8-04		
2 Piece Stack 8" Exhaust Package for Post-2003 Peterbilt 379 Reduced to 5 Y Pipe		
Part Number	Description	Quantity
Y9005-A24-A15-1103	5" Y Pipe	1
L9008-E29-B20-1103	90 Degree Elbow RDC 5"	2
50-09053	5" Band Clamp	4
50-02083	Angled Clamp	4
408E-055-1103	55" Spool	2
14-BU4656	Package of 8 Bushings	1
14-022998	Angled Bracket	2
1000142	Silicone	1



*Flex pipe NOT included
 *Set up for sleeper, Day cab, and non-unibilt cabs require 2 additional cab brackets



PETERBILT 379 EXHAUST- 1 PIECE KITS

HEIGHT GUIDE



P379-7-05		
1 Piece 7" Exhaust Package for Peterbilt 379 with Large Diameter Y Pipe		
Part Number	Description	Quantity
Y9007-E48-B15-1103	Large Diameter Y Pipe	1
L9007-E29-A24-1103	90 Degree Elbow LD	2
50-09053	5" Band Clamp	1
50-02073	Angled Clamp	4
50-00073	Bracketless Clamp	2
14-BU4656	Package of 8 Bushings	1
14-022998	Angled Bracket	2
1000142	Silicone	1

P379-8-05		
1 Piece 8" Exhaust Package for Peterbilt 379 with Large Diameter Y Pipe		
Part Number	Description	Quantity
Y9008-E48-B15-1103	Large Diameter Y Pipe	1
L9008-E29-A24-1103	90 Degree Elbow LD	2
50-09053	5" Band Clamp	1
50-02083	Angled Clamp	4
50-00083	Bracketless Clamp	2
14-BU4656	Package of 8 Bushings	1
14-022998	Angled Bracket	2
1000142	Silicone	1

P379-7-06		
1 Piece 7" Exhaust Package for Peterbilt 379 reduced to 5"		
Part Number	Description	Quantity
Y9005-A24-A15-1103	5" Y Pipe	1
L9007-E29-B20-1103	90 Degree Elbow RDC 5"	2
50-09053	5" Band Clamp	4
50-02073	Angled Clamp	4
14-BU4656	Package of 8 Bushings	1
14-022998	Angled Bracket	2
1000142	Silicone	1

P379-8-06		
1 Piece 8" Exhaust Package for Peterbilt 379 reduced to 5"		
Part Number	Description	Quantity
Y9005-A24-A15-1103	5" Y Pipe	1
L9008-E29-B20-1103	90 Degree Elbow RDC 5"	2
50-09053	5" Band Clamp	4
50-02083	Angled Clamp	4
14-BU4656	Package of 8 Bushings	1
14-022998	Angled Bracket	2
1000142	Silicone	1

*Flex pipe NOT included

Pre-2003 Trucks with 2 pc Kit		
Total Height**	Spool Length	Stack Length
11' 10"	52"	44"
12' 2"	52"	48"
12' 8"	52"	54"
13' 2"	52"	60"
13' 6"	52"	64"
13' 10"***	52"	68"

Post-2003 Trucks with 2 pc Kit		
Total Height**	Spool Length	Stack Length
11' 9"	55"	44"
12' 1"	55"	48"
12' 7"	55"	54"
13' 1"	55"	60"
13' 5"	55"	64"
13' 9"***	55"	68"

Pre-2003 Trucks with 1 pc Kit		
Total Height**		Stack Length
11' 8"		96"
12' 8"		108"
13' 2"		114"
13' 8"***		120"

Post-2003 Trucks with 1 pc Kit		
Total Height**		Stack Length
11' 9"		96"
12' 7"		108"
13' 1"		114"
13' 7"***		120"

** Total height is approximate and measured from ground to tip.

*** Denotes stack heights may be overheight and are not recommended by Lincoln Chrome



KENWORTH EXHAUST KITS

KW900-7-09 (2011-2017)		
7" Kenworth W900L with DPF Stainless Steel Exhaust Package		
Part Number	Description	Quantity
L9007-E15-A10.5-2103	7" SS Elbow	2
1000211-3	7-4 RH Clamp	1
1000210-3	7-4 Clamp	1
50-08073	7" Wide Sliding Clamp	2
50-09053	5" Band Clamp	2
1000212	LH Undercab Tube	1
1000213	RH Undercab Tube	1
50-09043	4" Band Clamp	1
HTS4100-500X-36	Precut Flex Tube	1
1000215	7-4 Clamp Hardware Kit	2
1000142	Silicone	1

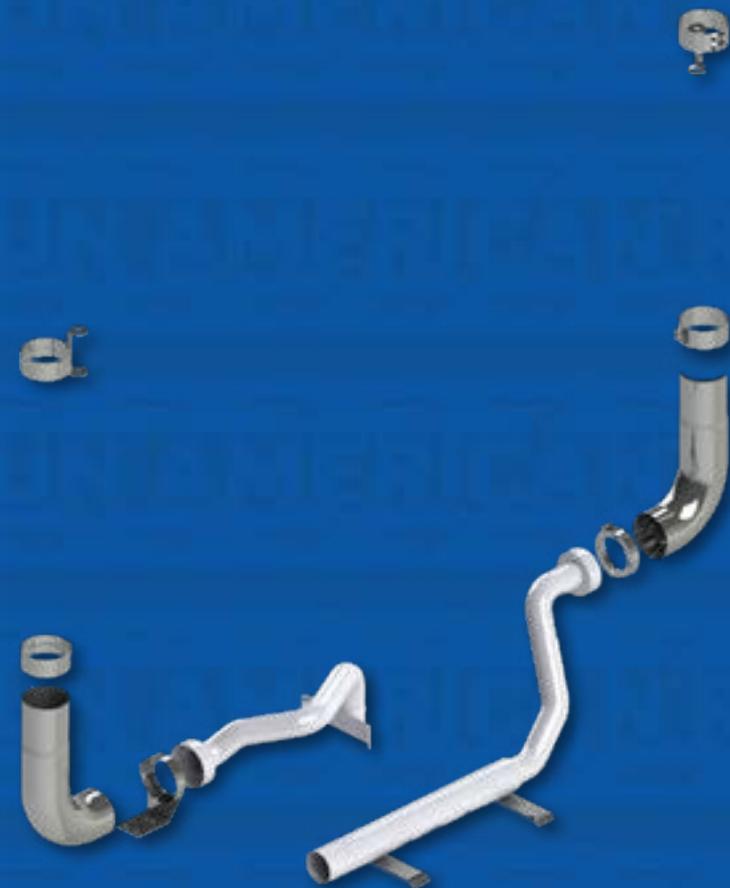

KENWORTH EXHAUST - 2 PIECE KITS

KW900-8-01		
2 Piece Stack 8" Exhaust Package for Kenworth W900L (18615 OEM Elbow)		
Part Number	Description	qty
KW08-E18615LB-1103	Left 8" 18615 Elbow	1
KW08-E18615RB-1103	Right 8" 18615 Elbow	1
408E-055-1103	55" Spool	2
50-11083	Frame Mount Clamp	2
50-00083	Bracketless Clamp	2
50-04083	Aero Kenworth Clamp	2
1000142	Silicone	1

KW900-6-01		
2 Piece Stack 6" Exhaust Package for Kenworth W900L (18615 OEM Elbow)		
Part Number	Description	qty
KW06-E18615LB-1103	Left 6" 18615 Elbow	1
KW06-E18615RB-1103	Right 6" 18615 Elbow	1
406E-055-1103	55" Spool	2
50-11063	Frame Mount Clamp	2
50-00063	Bracketless Clamp	2
50-04063	Aero Kenworth Clamp	2
1000142	Silicone	1

KW900-8-02		
2 Piece Stack 8" Exhaust Package for Kenworth W900L (1270 OEM Elbow)		
Part Number	Description	qty
KW08-E1270LB-1103	Left 8" 1270 Elbow	1
KW08-E1270RB-1103	Right 8" 1270 Elbow	1
408E-055-1103	55" Spool	2
50-11083	Frame Mount Clamp	2
50-00083	Bracketless Clamp	2
50-04083	Aero Kenworth Clamp	2
1000142	Silicone	1

KW900-6-02		
2 Piece Stack 6" Exhaust Package for Kenworth W900L (1270 OEM Elbow)		
Part Number	Description	qty
KW06-E1270LB-1103	Left 6" 1270 Elbow	1
KW06-E1270RB-1103	Right 6" 1270 Elbow	1
406E-055-1103	55" Spool	2
50-11063	Frame Mount Clamp	2
50-00063	Bracketless Clamp	2
50-04063	Aero Kenworth Clamp	2
1000142	Silicone	1

KW900-7-01		
2 Piece Stack 7" Exhaust Package for Kenworth W900L (18615 OEM Elbow)		
Part Number	Description	qty
KW07-E18615LB-1103	Left 7" 18615 Elbow	1
KW07-E18615RB-1103	Right 7" 18615 Elbow	1
407E-055-1103	55" Spool	2
50-11073	Frame Mount Clamp	2
50-00073	Bracketless Clamp	2
50-04073	Aero Kenworth Clamp	2
1000142	Silicone	1



KW900-7-02		
2 Piece Stack 7" Exhaust Package for Kenworth W900L (1270 OEM Elbow)		
Part Number	Description	qty
KW07-E1270LB-1103	Left 7" 1270 Elbow	1
KW07-E1270RB-1103	Right 7" 1270 Elbow	1
407E-055-1103	55" Spool	2
50-11073	Frame Mount Clamp	2
50-00073	Bracketless Clamp	2
50-04073	Aero Kenworth Clamp	2
1000142	Silicone	1





KENWORTH EXHAUST - 2 PIECE KITS

KENWORTH EXHAUST - 1 PIECE KITS

KW900-8-03		
2 Piece Stack 8" Exhaust Package for Kenworth W900L (18616 OEM Elbow)		
Part Number	Description	qty
KW08-E18616LB-1103	Left 8" 18616 Elbow	1
KW08-E18616RB-1103	Right 8" 18616 Elbow	1
408E-055-1103	55" Spool	2
50-11083	Frame Mount Clamp	2
50-00083	Bracketless Clamp	2
50-04083	Aero Kenworth Clamp	2
1000142	Silicone	1

KW900-7-03		
2 Piece Stack 7" Exhaust Package for Kenworth W900L (18616 OEM Elbow)		
Part Number	Description	qty
KW07-E18616LB-1103	Left 7" 18616 Elbow	1
KW07-E18616RB-1103	Right 7" 18616 Elbow	1
407E-055-1103	55" Spool	2
50-11073	Frame Mount Clamp	2
50-00073	Bracketless Clamp	2
50-04073	Aero Kenworth Clamp	2
1000142	Silicone	1

KW900-6-03		
2 Piece Stack 6" Exhaust Package for Kenworth W900L (18616 OEM Elbow)		
Part Number	Description	qty
KW06-E18616LB-1103	Left 6" 18616 Elbow	1
KW06-E18616RB-1103	Right 6" 18616 Elbow	1
406E-055-1103	55" Spool	2
50-11063	Frame Mount Clamp	2
50-00063	Bracketless Clamp	2
50-04063	Aero Kenworth Clamp	2
1000142	Silicone	1



KW900-8-04		
2 Piece Stack 8" Exhaust Package for Kenworth W900L (1271 OEM Elbow)		
Part Number	Description	qty
KW08-E1271LB-1103	Left 8" 1271 Elbow	1
KW08-E1271RB-1103	Right 8" 1271 Elbow	1
408E-055-1103	55" Spool	2
50-11083	Frame Mount Clamp	2
50-00083	Bracketless Clamp	2
50-04083	Aero Kenworth Clamp	2
1000142	Silicone	1

KW900-7-04		
2 Piece Stack 8" Exhaust Package for Kenworth W900L (1271 OEM Elbow)		
Part Number	Description	qty
KW07-E1271LB-1103	Left 7" 1271 Elbow	1
KW07-E1271RB-1103	Right 7" 1271 Elbow	1
407E-055-1103	55" Spool	2
50-11073	Frame Mount Clamp	2
50-00073	Bracketless Clamp	2
50-04073	Aero Kenworth Clamp	2
1000142	Silicone	1

KW900-6-04		
2 Piece Stack 8" Exhaust Package for Kenworth W900L (1271 OEM Elbow)		
Part Number	Description	qty
KW06-E1271LB-1103	Left 6" 1271 Elbow	1
KW06-E1271RB-1103	Right 6" 1271 Elbow	1
406E-055-1103	55" Spool	2
50-11063	Frame Mount Clamp	2
50-00063	Bracketless Clamp	2
50-04063	Aero Kenworth Clamp	2
1000142	Silicone	1



KW900-8-05		
1 Piece 8" Exhaust Package for Kenworth W900L (18615 OEM Elbow)		
Part Number	Description	QTY
KW08-E18615LB-1103	Left 8" 18615 Elbow	1
KW08-E18615RB-1103	Right 8" 18615 Elbow	1
50-11083	Frame Mount Clamp	2
50-00083	Bracketless Clamp	2
50-04083	Aero Kenworth Clamp	2
1000142	Silicone	1

KW900-7-05		
1 Piece 7" Exhaust Package for Kenworth W900L (18615 OEM Elbow)		
Part Number	Description	QTY
KW07-E18615LB-1103	Left 7" 18615 Elbow	1
KW07-E18615RB-1103	Right 8" 18615 Elbow	1
50-11073	Frame Mount Clamp	2
50-00073	Bracketless Clamp	2
50-04073	Aero Kenworth Clamp	2
1000142	Silicone	1

KW900-6-05		
1 Piece 6" Exhaust Package for Kenworth W900L (18615 OEM Elbow)		
Part Number	Description	QTY
KW06-E18615LB-1103	Left 6" 18615 Elbow	1
KW06-E18615RB-1103	Right 6" 18615 Elbow	1
50-11063	Frame Mount Clamp	2
50-00063	Bracketless Clamp	2
50-04063	Aero Kenworth Clamp	2
1000142	Silicone	1



KW900-8-06		
1 Piece 8" Exhaust Package for Kenworth W900L (1270 OEM Elbow)		
Part Number	Description	QTY
KW08-E1270LB-1103	Left 8" 1270 Elbow	1
KW08-E1270RB-1103	Right 8" 1270 Elbow	1
50-11083	Frame Mount Clamp	2
50-00083	Bracketless Clamp	2
50-04083	Aero Kenworth Clamp	2
1000142	Silicone	1

KW900-7-06		
1 Piece 7" Exhaust Package for Kenworth W900L (1270 OEM Elbow)		
Part Number	Description	QTY
KW07-E1270LB-1103	Left 7" 1270 Elbow	1
KW07-E1270RB-1103	Right 7" 1270 Elbow	1
50-11073	Frame Mount Clamp	2
50-00073	Bracketless Clamp	2
50-04073	Aero Kenworth Clamp	2
1000142	Silicone	1

KW900-6-06		
1 Piece 6" Exhaust Package for Kenworth W900L (1270 OEM Elbow)		
Part Number	Description	QTY
KW06-E1270LB-1103	Left 6" 1270 Elbow	1
KW06-E1270RB-1103	Right 6" 1270 Elbow	1
50-11063	Frame Mount Clamp	2
50-00063	Bracketless Clamp	2
50-04063	Aero Kenworth Clamp	2
1000142	Silicone	1

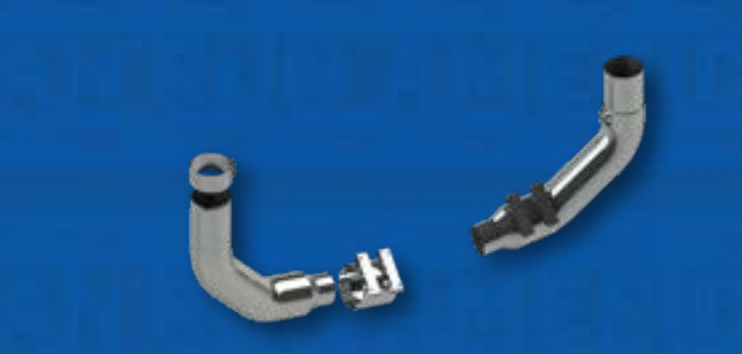



KENWORTH EXHAUST - 1 PIECE KITS

FREIGHTLINER EXHAUST KITS

KW900-8-07		
1 Piece 8" Exhaust Package for Kenworth W900L (18616 OEM Elbow)		
Part Number	Description	QTY
KW08-E18616LB-1103	Left 8" 18616 Elbow	1
KW08-E18616RB-1103	Right 8" 18616 Elbow	1
50-11083	Frame Mount Clamp	2
50-00083	Bracketless Clamp	2
50-04083	Aero Kenworth Clamp	2
1000142	Silicone	1

KW900-7-07		
1 Piece 7" Exhaust Package for Kenworth W900L (18616 OEM Elbow)		
Part Number	Description	QTY
KW07-E18616LB-1103	Left 7" 18616 Elbow	1
KW07-E18616RB-1103	Right 7" 18616 Elbow	1
50-11073	Frame Mount Clamp	2
50-00073	Bracketless Clamp	2
50-04073	Aero Kenworth Clamp	2
1000142	Silicone	1

KW900-6-07		
1 Piece 6" Exhaust Package for Kenworth W900L (18616 OEM Elbow)		
Part Number	Description	QTY
KW06-E18616LB-1103	Left 6" 18616 Elbow	1
KW06-E18616RB-1103	Right 6" 18616 Elbow	1
50-11063	Frame Mount Clamp	2
50-00063	Bracketless Clamp	2
50-04063	Aero Kenworth Clamp	2
1000142	Silicone	1



KW900-8-08		
1 Piece 8" Exhaust Package for Kenworth W900L (1271 OEM Elbow)		
Part Number	Description	QTY
KW08-E1271LB-1103	Left 8" 1271 Elbow	1
KW08-E1271RB-1103	Right 8" 1271 Elbow	1
50-11083	Frame Mount Clamp	2
50-00083	Bracketless Clamp	2
50-04083	Aero Kenworth Clamp	2
1000142	Silicone	1

KW900-7-08		
1 Piece 7" Exhaust Package for Kenworth W900L (1271 OEM Elbow)		
Part Number	Description	QTY
KW07-E1271LB-1103	Left 7" 1271 Elbow	1
KW07-E1271RB-1103	Right 7" 1271 Elbow	1
50-11073	Frame Mount Clamp	2
50-00073	Bracketless Clamp	2
50-04073	Aero Kenworth Clamp	2
1000142	Silicone	1

KW900-6-08		
1 Piece 6" Exhaust Package for Kenworth W900L (1271 OEM Elbow)		
Part Number	Description	QTY
KW06-E1271LB-1103	Left 6" 1271 Elbow	1
KW06-E1271RB-1103	Right 6" 1271 Elbow	1
50-11063	Frame Mount Clamp	2
50-00063	Bracketless Clamp	2
50-04063	Aero Kenworth Clamp	2
1000142	Silicone	1



FREIGHTLINER CLASSIC

FLCL-7-02		
1 Piece 7" Exhaust Package for Freightliner Classic		
Part Number	Description	Quantity
FL07-E6015B-1103	7" Freightliner Elbow	2
50-07073	Universal Clamp	4
1000142	Silicone	1

FLCL-8-02		
1 Piece 8" Exhaust Package for Freightliner Classic		
Part Number	Description	Quantity
FL08-E6015B-1103	8" Freightliner Elbow	2
50-07083	Universal Clamp	4
1000142	Silicone	1

FLCL-7-01		
2 Piece Stack 7" Exhaust Package for Freightliner Classic		
Part Number	Description	Quantity
FL07-E6015B-1103	7" Freightliner Elbow	2
407E-052-1103	52" Spool	2
50-07073	Universal Clamp	4
1000142	Silicone	1

FLCL-8-01		
2 Piece Stack 8" Exhaust Package for Freightliner Classic		
Part Number	Description	Quantity
FL08-E6015B-1103	8" Freightliner Elbow	2
408E-052-1103	52" Spool	2
50-07083	Universal Clamp	4
1000142	Silicone	1



FREIGHTLINER CORONADO

FLCR-7-1		
1 Piece chrome plated stainless steel 7" Exhaust Package for Freightliner Coronado		
Part Number	Description	Quantity
L9007-E15-B15-2103	7" Freightliner Elbow	2
50-13073	Top Coronado Clamp	2
50-14073	Bottom Coronado Clamp	2
1000142	Silicone	1





FITMENT GUIDE FOR NON-KIT EXHAUST SYSTEMS

PETERBILT 359

__ Denotes Diameter (5, 6, 7, 8)

OEM STYLE ELBOWS

Unibuilt sleeper		
Part Number	Description	Quantity
Y9005-A24-A15-1103	Y Pipe	1
L600_-E10-B14-1103	60 Degree Elbows	2
40_E-055-1103	Spools	2
50-020_3	Angled Clamps	4
50-09053	5" Band Clamps	4
14-BU4656	Package of 8 Bushings	1
14-022998	Angled Brackets	2
1000142	Silicone	1

daycab & Non-Unibilt sleeper		
Part Number	Description	Quantity
Y9005-A24-A15-1103	Y Pipe	1
L600_-E10-B14-1103	60 Degree Elbows	2
40_E-055-1103	Spools	2
50-020_3	Angled Clamps	4
50-09053	5" Band Clamps	4
14-BU4656	Package of 8 Bushings	1
14-022998	Angled Brackets	4
1000142	Silicone	1

90 degree elbows - reduced to 5"

Unibuilt sleeper		
Part Number	Description	Quantity
Y9005-A24-A15-1103	Y Pipe	1
L900_-E29-B20-1103	90 Degree Elbows	2
40_E-055-1103	Spools	2
50-020_3	Angled Clamps	4
50-09053	5" Band Clamps	4
14-BU4656	Package of 8 Bushings	1
14-022998	Angled Brackets	2
1000142	Silicone	1

daycab & Non-Unibilt sleeper		
Part Number	Description	Quantity
Y9005-A24-A15-1103	Y Pipe	1
L900_-E29-B20-1103	90 Degree Elbows	2
40_E-055-1103	Spools	2
50-020_3	Angled Clamps	4
50-09053	5" Band Clamps	4
14-BU4656	Package of 8 Bushings	1
14-022998	Angled Brackets	4
1000142	Silicone	1

90 degree elbows - Full Diameter

Unibuilt sleeper		
Part Number	Description	Quantity
Y900_-E48-B15-1103	Y Pipe	1
L900_-E29-A24-1103	90 Degree Elbows	2
40_E-055-1103	Spools	2
50-020_3	Angled Clamps	4
50-09053	5" Band Clamps	4
14-BU4656	Package of 8 Bushings	1
14-022998	Angled Brackets	2
1000142	Silicone	1

daycab & Non-Unibilt sleeper		
Part Number	Description	Quantity
Y900_-E48-B15-1103	Y Pipe	1
L900_-E29-A24-1103	90 Degree Elbows	2
40_E-055-1103	Spools	2
50-020_3	Angled Clamps	4
50-09053	5" Band Clamps	4
14-BU4656	Package of 8 Bushings	1
14-022998	Angled Brackets	4
1000142	Silicone	1

* Flex pipe Needed

FITMENT GUIDE FOR NON-KIT EXHAUST SYSTEMS

KENWORTH

__ Denotes Diameter (6, 7, 8)

over the frame - Kenworth W900B 1982-2003		
part number	Description	quantity
KW0__-E14764LB-1103	Left Elbow	1
KW0__-E4764RB-1103	Right Elbow	1
40__E-052-1103 (2)	Spools	2
50-000__3 (2)	Bracket-less Clamps	2
50-030__3 (2)	Kenworth 4-Holed Clamps	2
1000142 (1)	Silicone	1

Over the Frame - Kenworth W900A 1967-1982		
part number	Description	quantity
KW0__-E10742Ld-1103	Left Elbow	1
KW0__-E10742RB-1103	Right Elbow	1
40__E-052-1103 (2)	Spools	2
50-000__3 (2)	Bracket-less Clamps	2
50-030__3 (2)	Kenworth 4-Holed Clamps	2
1000142 (1)	Silicone	1

over the frame - Kenworth T600 1986-2003		
part number	Description	quantity
KW0__-E14764LB-1103	Left Elbow	1
KW0__-E4764RB-1103	Right Elbow	1
40__E-052-1103 (2)	Spools	2
50-000__3 (2)	Bracket-less Clamps	2
50-030__3 (2)	Kenworth 4-Holed Clamps	2
1000142 (1)	Silicone	1

over the frame - Kenworth T800 1986-2003		
PART number	Description	quantity
KW0__-E14764LB-1103	Left Elbow	1
KW0__-E4764RB-1103	Right Elbow	1
40__E-052-1103 (2)	Spools	2
50-000__3 (2)	Bracket-less Clamps	2
50-030__3 (2)	Kenworth 4-Holed Clamps	2
1000142 (1)	Silicone	1



FITMENT GUIDE FOR NON-KIT EXHAUST SYSTEMS

FREIGHTLINER

__ Denotes Diameter (6, 7, 8)

Freightliner FLD120 1985-2006		
part number	Description	quantity
FL0__-E6015B-1103 (2)	Elbows	2
40__E-052-1103 (2)	Spools	2
50-070__3 (4)	Universal Clamps	4
1000142 (1)	Silicone	1

WESTERN STAR

__ Denotes Diameter (6, 7, 8)

Western Star Constellation Cab 1989-present		
Part number	Description	quantity
FL0__-E6015B-1103 (2)	Elbows	2
40__E-052-1103 (2)	Spools	2
50-060__3 (4)	Western Star 3.38" Clamp	4
1000142 (1)	Silicone	1

Western Star 4900 Heritage 1988-1999		
part number	Description	quantity
FL0__-E6015B-1103 (2)	Elbows	2
40__E-052-1103 (2)	Spools	2
50-050__3 (4)	Western Star 2.25" Clamp	4
1000142 (1)	Silicone	1

EXHAUST COMPONENTS





ELITE FINISH

STAND ABOVE THE REST

Miter Top Stacks

Height	7" Part Number	8" Part Number
36"	EL107A-036-1103	EL108A-036-1103
44"	EL107A-044-1103	EL108A-044-1103
48"	EL107A-048-1103	EL108A-048-1103
54"	EL107A-054-1103	EL108A-054-1103
60"	EL107A-060-1103	EL108A-060-1103
64"	EL107A-064-1103	EL108A-064-1103
68"	EL107A-068-1103	EL108A-068-1103
72"	EL107A-072-1103	EL108A-072-1103

Flat Top Stacks

Height	7" Part Number	8" Part Number
36"	EL407A-036-1103	EL408A-036-1103
44"	EL407A-044-1103	EL408A-044-1103
48"	EL407A-048-1103	EL408A-048-1103
54"	EL407A-054-1103	EL408A-054-1103
60"	EL407A-060-1103	EL408A-060-1103
64"	EL407A-064-1103	EL408A-064-1103
68"	EL407A-068-1103	EL408A-068-1103
72"	EL407A-072-1103	EL408A-072-1103

90 Degree Elbows

Diameter	7" Part Number	8" Part Number
Reduced	ELL9007-E29-B20-1103	ELL9008-E29-B20-1103
Full Diameter	ELL9007-E29-A24-1103	ELL9008-E29-A24-1103

Spools

Height	7" Part Number	8" Part Number
48"	EL407E-048-1103	EL408E-048-1103
52"	EL407E-052-1103	EL408E-052-1103
55"	EL407E-055-1103	EL408E-055-1103



BE ELITE



Please contact A Lincoln Chrome Representative with any questions at 888-966-6609 or cs@lincolnchrome.com.

TOP STYLES / END FORMS GUIDE

STACK PART NUMBER DEFINITION

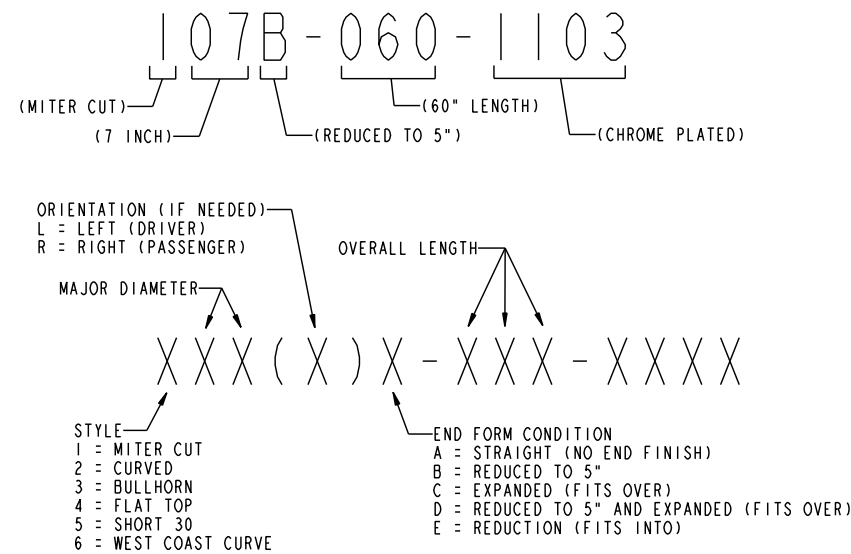

ELBOW PART NUMBER DEFINITION

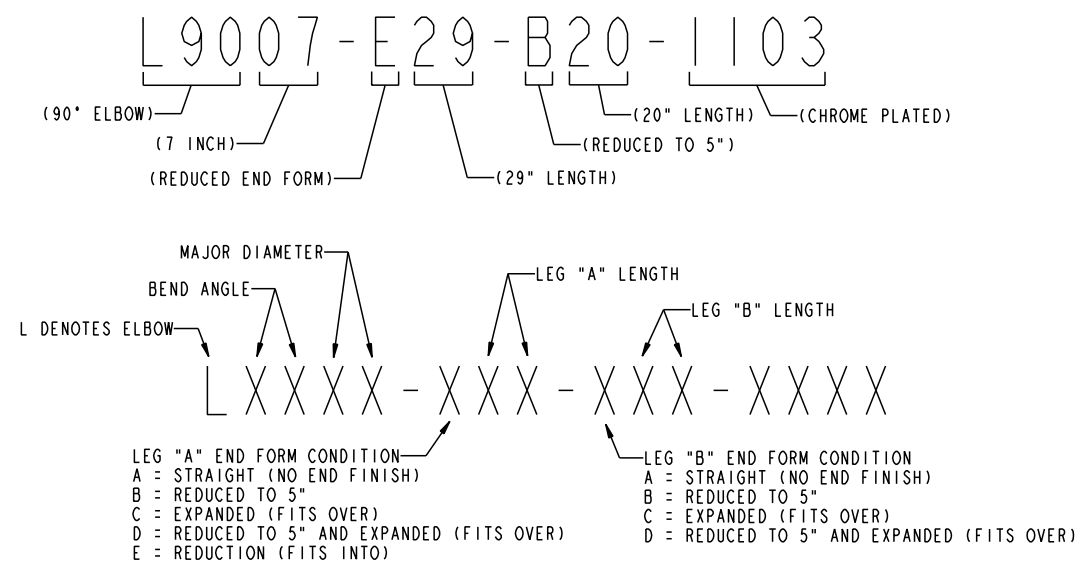

1103 Chrome Plated Carbon Steel
2103 Chrome Plated Stainless Steel

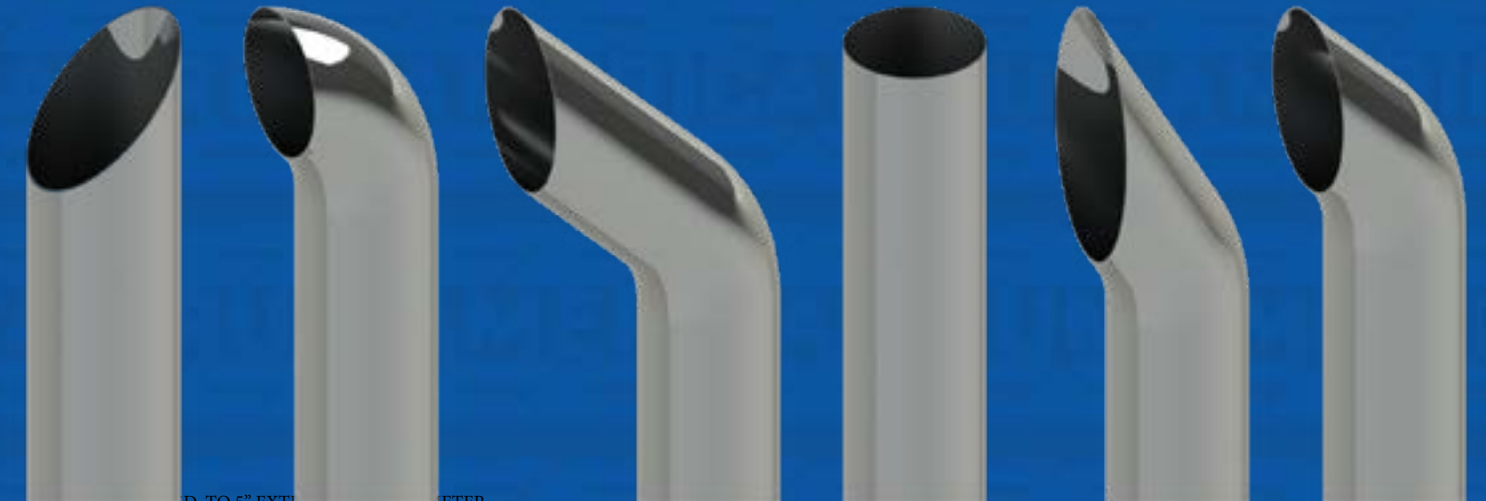

- 1**
MITER
- 2**
CURVE
- 3**
BULLHORN
- 4**
FLAT TOP
- 5**
SHORT 30
- 6**
WEST COAST CURVE

- A**
OD W/
SEAMLESS
ELBOW
- B**
REDUCED TO 5"
OD DIAMETER
- C**
ID, SLIDES
OVER ELBOW
- D**
REDUCED TO 5"
ID DIAMETER
- G**
REDUCED TO
5" EXTENDED
OD DIAMETER





CHROME STACKS / 5" - 8"

__ denotes diameter | substitute 5, 6, 7, 8 when ordering



Miter Curve

Height	Miter	Curve
24"	10_A*-024-1103	20_A-024-1103
36"	10_A-036-1103	20_A-036-1103
44"	10_A-044-1103	20_A-044-1103
48"	10_A-048-1103	20_A-048-1103
54"	10_A-054-1103	20_A-054-1103
60"	10_A-060-1103	20_A-060-1103
64"	10_A-064-1103	20_A-064-1103
68"	10_A-068-1103	20_A-068-1103
72"	10_A-072-1103	20_A-072-1103
84"	10_A-084-1103	20_A-084-1103
96"	10_A-096-1103	20_A-096-1103
108"	10_A-108-1103	20_A-108-1103
114"	10_A-114-1103	20_A-114-1103
120"	10_A-120-1103	20_A-120-1103

CHROME STACKS / 5" - 8"

__ denotes diameter | substitute 5, 6, 7, 8 when ordering

Height	Short 30	West Coast Curve
24"	50_A*-024-1103	60_A-024-1103
36"	50_A-036-1103	60_A-036-1103
44"	50_A-044-1103	60_A-044-1103
48"	50_A-048-1103	60_A-048-1103
54"	50_A-054-1103	60_A-054-1103
60"	50_A-060-1103	60_A-060-1103
64"	50_A-064-1103	60_A-064-1103
68"	50_A-068-1103	60_A-068-1103
72"	50_A-072-1103	60_A-072-1103
84"	50_A-084-1103	60_A-084-1103
96"	50_A-096-1103	60_A-096-1103
108"	50_A-108-1103	60_A-108-1103
114"	50_A-114-1103	60_A-114-1103
120"	50_A-120-1103	60_A-120-1103



Short 30 West Coast Curve

__ denotes diameter | substitute 5, 6, 7, 8 when ordering



Bullhorn Flat Top

Height	Bullhorn	Flat Top
24"	30_A-024-1103	40_A-024-1103
36"	30_A-036-1103	40_A-036-1103
44"	30_A-044-1103	40_A-044-1103
48"	30_A-048-1103	40_A-048-1103
54"	30_A-054-1103	40_A-054-1103
60"	30_A-060-1103	40_A-060-1103
64"	30_A-064-1103	40_A-064-1103
68"	30_A-068-1103	40_A-068-1103
72"	30_A-072-1103	40_A-072-1103
84"	30_A-084-1103	40_A-084-1103
96"	30_A-096-1103	40_A-096-1103
108"	30_A-108-1103	40_A-108-1103
114"	30_A-114-1103	40_A-114-1103
120"	30_A-120-1103	40_A-120-1103

* A designates OD stack (works with seamless design elbow)
 B designates stack is reduced to 5 inch OD (slides into muffler)
 C designates ID stack
 D designates stack is reduced to 5 inch ID (slides over 5 inch OD elbow)
 G designates Reduced to 5" extended OD diameter

* A designates OD stack (works with seamless design elbow)
 B designates stack is reduced to 5 inch OD (slides into muffler)
 C designates ID stack
 D designates stack is reduced to 5 inch ID (slides over 5 inch OD elbow)
 G designates Reduced to 5" extended OD diameter



CHROME ELBOWS

90° Seamless Chrome Elbows



Leg Length				
DIA	Reduced to	Top Leg*	Lower Leg**	Part Number
5		29	24	L9005-E29-A24-1103
6	5	29	20	L9006-E29-B20-1103
7	5	29	20	L9007-E29-B20-1103
8	5	29	20	L9008-E29-B20-1103
6		29	24	L9006-E29-A24-1103
7		29	24	L9007-E29-A24-1103
8		29	24	L9008-E29-A24-1103

68° Chrome Elbows



Leg Length				
DIA	Reduced to	Top Leg*	Lower Leg**	Part Number
6	5	15	17	L6806-E15-B17-1103
7	5	15	17	L6807-E15-B17-1103
8	5	15	17	L6808-E15-B17-1103

60° Chrome Elbows

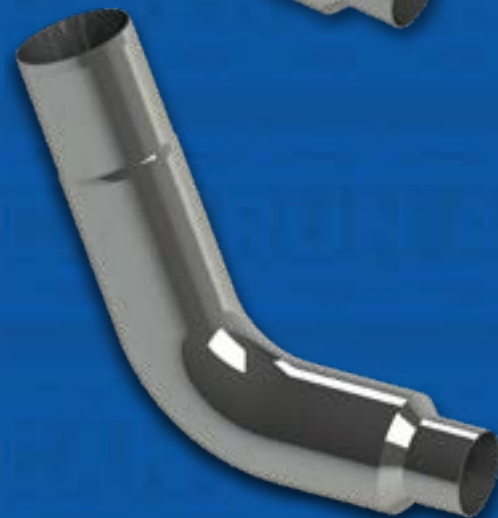

Leg Length				
DIA	Reduced to	Top Leg*	Lower Leg**	Part Number
5		14	14	L6005-A14-A14-1103
6	5	10	14	L6006-E10-B14-1103
7	5	10	14	L6007-E10-B14-1103
8	5	10	14	L6008-E10-B14-1103
5		16	16	L6005-A16-A16-1103
6		9	23	L6006-E09-A23-1103
7		9	24	L6007-E09-A24-1103
8		8	25	L6008-E08-A25-1103

* A designates OD diameter, requires "C" end form stack
E designates tapered to fit inside of OD ("A" end form) top stack

**A designates OD diameter, no end form
nates lower leg is reduced to 5 inch OD
C designates expanded to ID diameter

B design-

CHROME ELBOWS

FREIGHTLINER CHROME ELBOWS



Leg Length				
DIA	Reduced to	Top Leg	Lower Leg	Part Number
6	5	10	15	FL06-E6015B-1103
7	5	10	15	FL07-E6015B-1103
8	5	10	17	FL08-E6015B-1103

UNIVERSAL 90° CHROME ELBOWS



Leg Length				
DIA	Reduced to	Top Leg*	Lower Leg**	Part Number
5		14	14	L9005-A14-A14-1103
5		14	14	L9005-E14-A14-1103
6	5	15	15	L9006-E15-B15-1103
6	5	20	20	L9006-E20-B20-1103
6	5	23	23	L9006-E23-B23-1103
7	5	15	15	L9007-E15-B15-1103
7	5	20	20	L9007-E20-B20-1103
7	5	26	26	L9007-E26-B26-1103
8	5	15	17	L9008-E15-B17-1103

* A designates OD diameter, requires "C" end form stack
E designates tapered to fit inside of OD ("A" end form) top stack

**A designates OD diameter, no end form
B designates lower leg is reduced to 5 inch OD
C designates expanded to ID diameter



MULTI-BEND CHROME ELBOWS

Reduced to	6 inch	7 inch	8 inch
5	KW06-E14764LB-1103	KW07-E14764LB-1103	KW08-E14764LB-1103
5	KW06-E14764RB-1103	KW07-E14764RB-1103	KW08-E14764RB-1103
5	KW06-E18615LB-1103	KW07-E18615LB-1103	KW08-E18615LB-1103
5	KW06-E18615RB-1103	KW07-E18615RB-1103	KW08-E18615RB-1103
5	KW06-E18616LB-1103	KW07-E18616LB-1103	KW08-E18616LB-1103
5	KW06-E18616RB-1103	KW07-E18616RB-1103	KW08-E18616RB-1103
5	KW06-E1270LB-1103	KW07-E1270LB-1103	KW08-E1270LB-1103
5	KW06-E1270RB-1103	KW07-E1270RB-1103	KW08-E1270RB-1103
5	KW06-E1271LB-1103	KW07-E1271LB-1103	KW08-E1271LB-1103
5	KW06-E1271RB-1103	KW07-E1271RB-1103	KW08-E1271RB-1103
5	KW06-E10742LD-1103	KW07-E10742LD-1103	
5	KW06-E10742RB-1103	KW07-E10742RB-1103	

IMPORTANT: Verify existing OEM # for accuracy



CHROME SPOOLS & Y-PIPES

Chrome Spools

Diameter/Height	5 inch	6 inch	7 inch	8 inch
48"	405E-048-1103	406E-048-1103	407E-048-1103	408E-048-1103
52"	405E-052-1103	406E-052-1103	407E-052-1103	408E-052-1103
55"	405E-055-1103	406E-055-1103	407E-055-1103	408E-055-1103
60"	405E-060-1103	406E-060-1103	407E-060-1103	408E-060-1103



Chrome Quiet Spools

Diameter/Height	7 inch	8 inch
48"	QS-407E-048-1103	QS-408E-048-1103
52"	QS-407E-052-1103	QS-408E-052-1103
55"	QS-407E-055-1103	QS-408E-055-1103
60"	QS-407E-060-1103	QS-408E-060-1103

Chrome Small Y-Pipes

Y-Pipe Part Number	Description
Y9005-A24-A15-1103	Small 5" (T Pipe)
Y9005-A24-C15-1103	Small 5" (ID inlet)

Add Band Clamps
See Page 38

Add Flex Piping
See Page 39



Chrome Large Y-Pipes

DIA	Reduced to	90 Degree Y-Pipe
5		Y9005-E60-A16-1103
6	5	Y9006-E48-B15-1103
7	5	Y9007-E48-B15-1103
8	5	Y9008-E48-B15-1103



90 Degree Y-Pipe



CHROME CLAMPS

WIDE CHROME CLAMPS

Description	5 Inch	6 inch	7 inch	8 inch
Bracketless Clamp	50-00053	50-00063	50-00073	50-00083
Straight Peterbilt Clamp	50-01053	50-01063	50-01073	50-01083
Angled Peterbilt Clamp	50-02053	50-02063	50-02073	50-02083
4-Holed Kenworth Clamp	50-03053	50-03063	50-03073	50-03083
Aero Kenworth Clamp	50-04053	50-04063	50-04073	50-04083
Western Star Clamp - 2.5" hole spacing	50-05053	50-05063	50-05073	50-05083
Western Star Clamp - 3.38" hole spacing	50-06053	50-06063	50-06073	50-06083
Universal Clamp	50-07053	50-07063	50-07073	50-07083
Band Clamp	50-09053	N/A	50-09073	50-09083
Extra Wide Kenworth Frame Mount Clamp	50-11053	50-11063	50-11073	50-11083
Top Coronado Clamp			50-13073	
Bottom Coronado Clamp			50-14073	

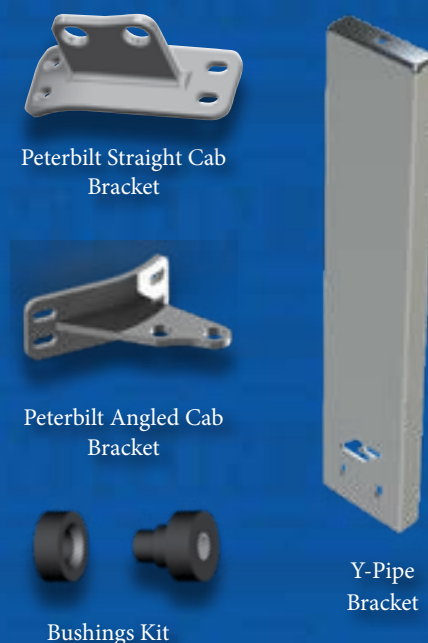

CHROME BRACKETS & BUSHINGS

Part Number	Description
14-012998	Peterbilt, Cab Bracket, Straight, Chrome
14-022998	Peterbilt, Cab Bracket, Angled Chrome
14-062998	Y-Pipe Support Bracket
14-BU4656	Package of 8 Bushings

CHROME ADAPTERS

Part Number	Description
ADP6D	6" to 5" chrome adapter, expanded/slotted
ADP7D	7" to 5" chrome adapter, expanded/slotted
ADP8D	8" to 5" chrome adapter, expanded/slotted
ADP6B	6" reduced to 5" chrome adapter
ADP7B	7" reduced to 5" chrome adapter
ADP8B	8" reduced to 5" chrome adapter

FLEX PIPING*

Part Number	Description
HTS4100-500X36	5"x 36" Universal Flex Piping
HTS4100-600X36	6"x 36" Universal Flex Piping
HTS4100-700X36	7"x 36" Universal Flex Piping
HTS4100-800X36	8"x 36" Universal Flex Piping

* Stainless Steel



Bumpers

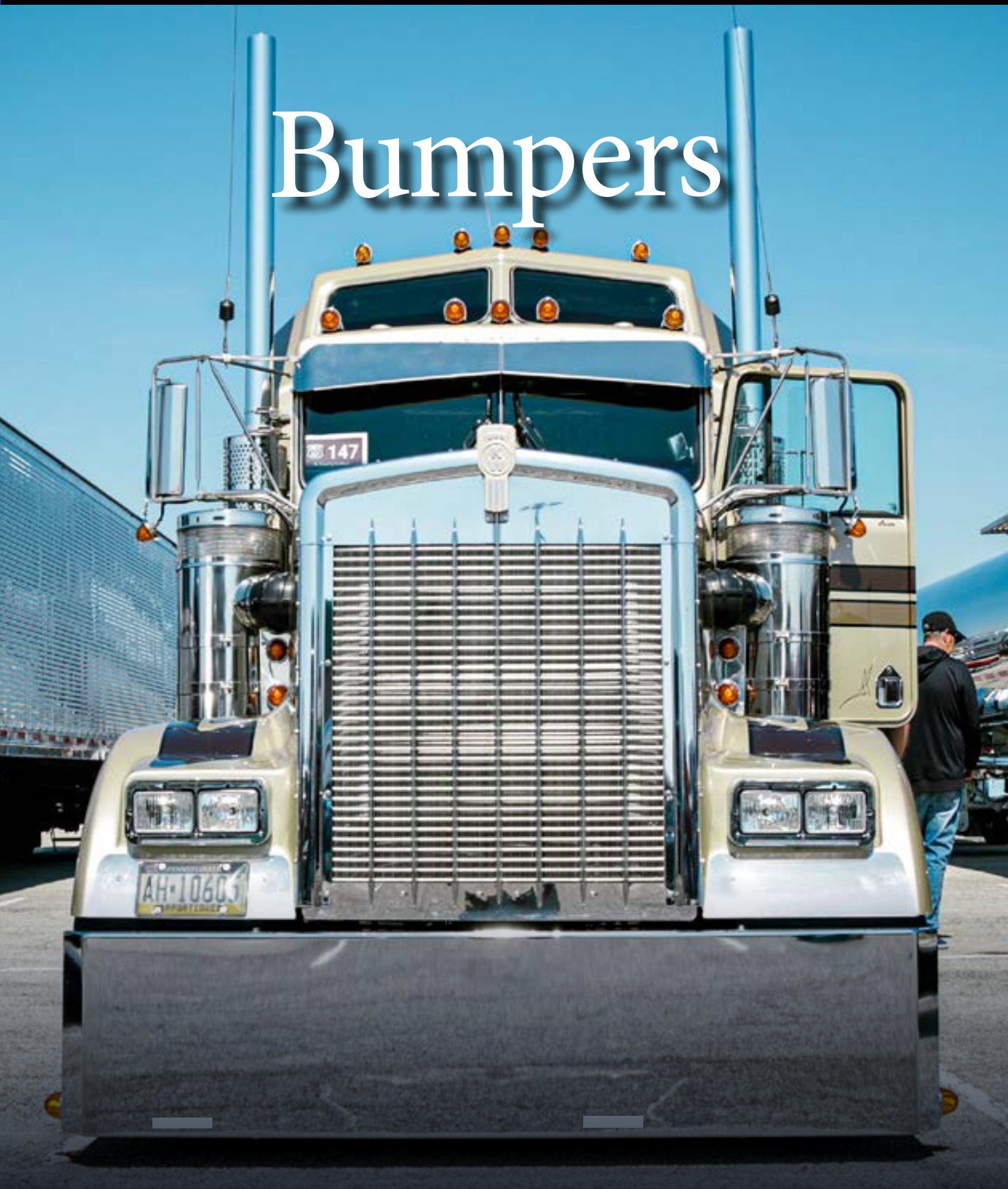

CHROME PLATED BUMPERS

10 Gauge Chrome plated carbon steel
11 Gauge Chrome plated stainless steel

BUMPER PART NUMBER DEFINITION

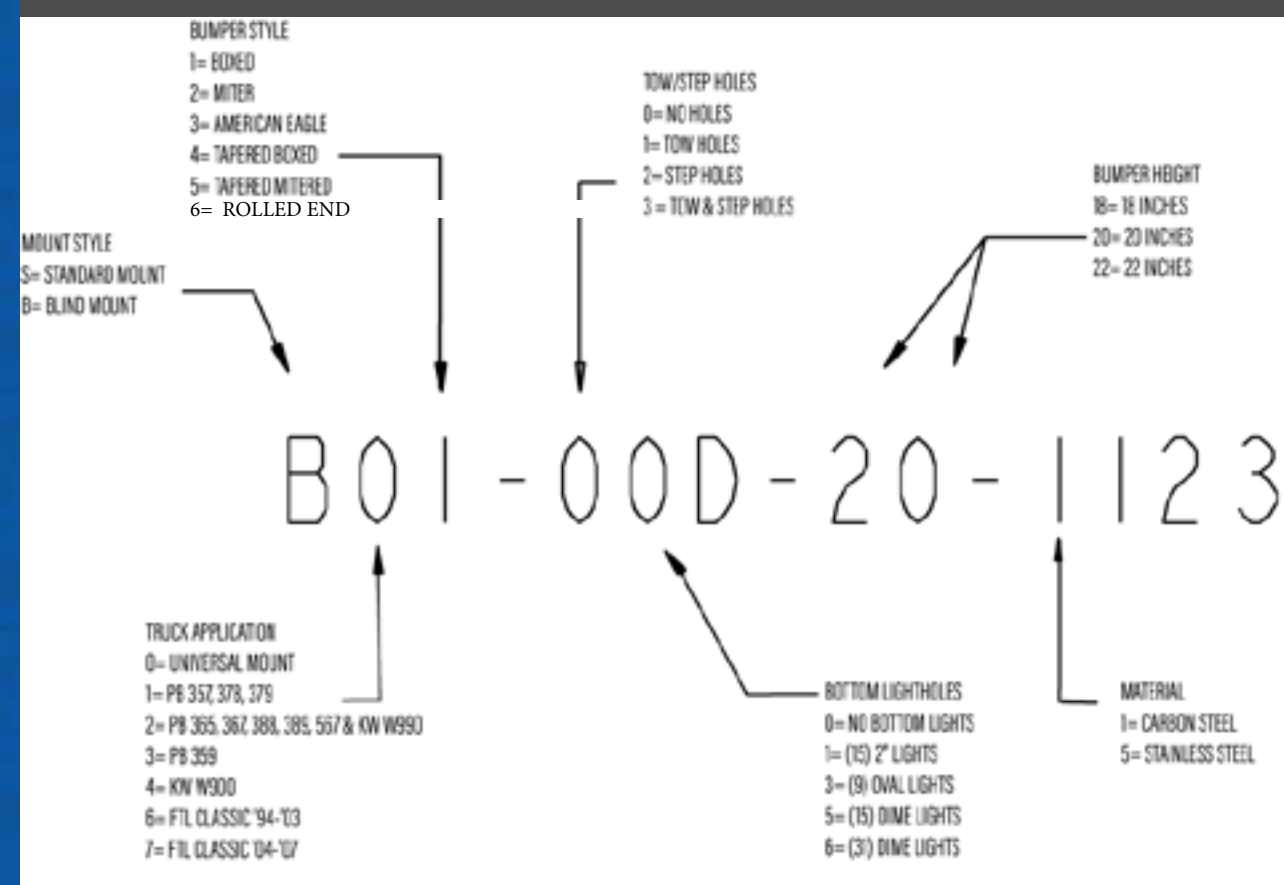



BUMPER STYLES

PETERBILT 389 & 589

also fits 352, 365, 367, 388, 567 &
& Kenworth W990

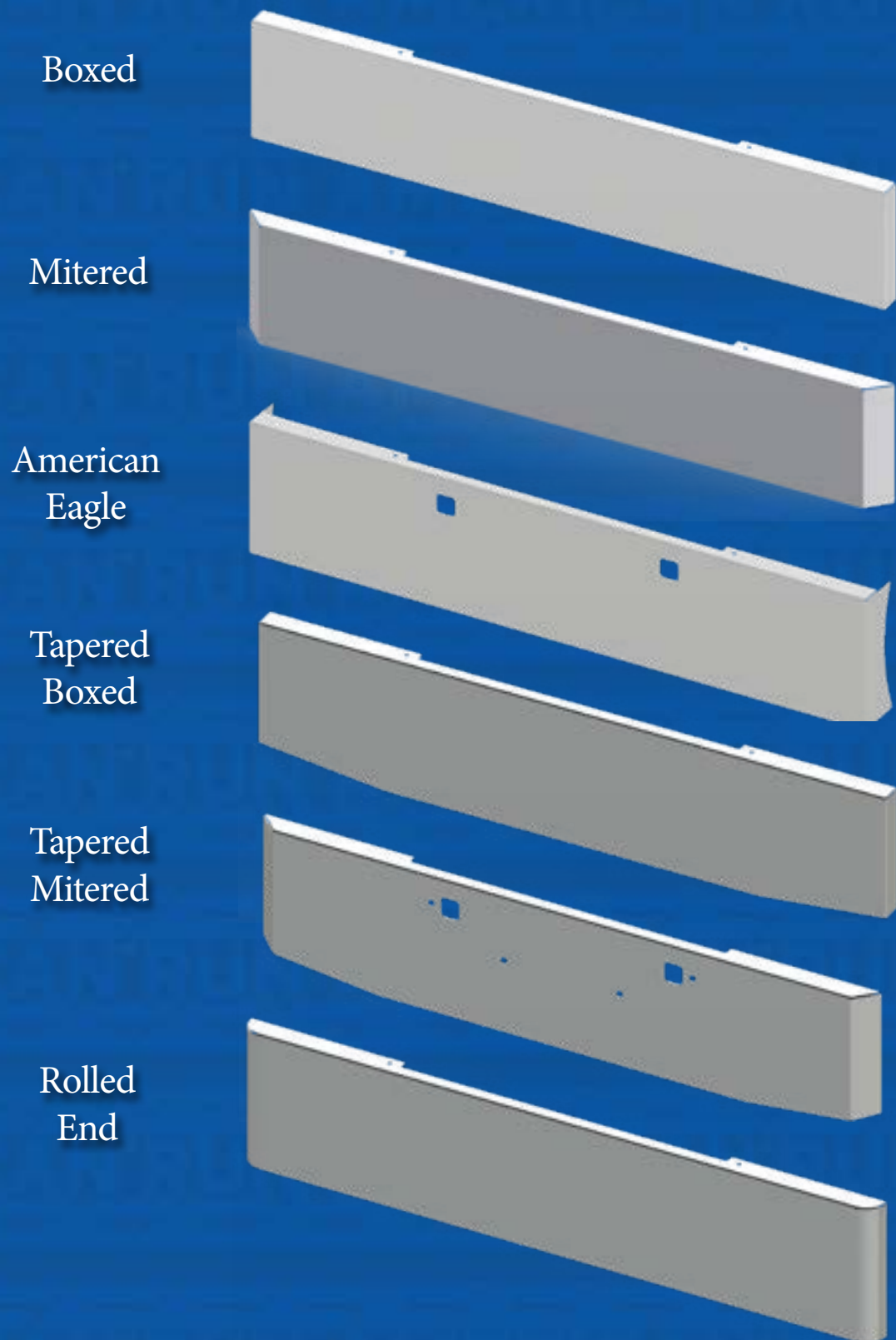

Style	Description	18"	20"	22"
Boxed	Blind, No Holes	B01-00D-18-1123	B01-00D-20-1123	B01-00D-22-1123
	Blind, Tow Holes	B21-10D-18-1123	B21-10D-20-1123	B21-10D-22-1123
	Standard, No Holes	S21-00D-18-1123	S21-00D-20-1123	S21-00D-22-1123
	Standard, Tow Holes	S21-10D-18-1123	S21-10D-20-1123	S21-10D-22-1123
Mitered	Blind, No Holes	B02-00D-18-1123	B02-00D-20-1123	B02-00D-22-1123
	Blind, Tow Holes	B22-10D-18-1123	B22-10D-20-1123	B22-10D-22-1123
	Standard, No Holes	S22-00D-18-1123	S22-00D-20-1123	S22-00D-22-1123
	Standard, Tow Holes	S22-10D-18-1123	S22-10D-20-1123	S22-10D-22-1123
American Eagle	Blind, No Holes	B03-00D-18-1123	B03-00D-20-1123	B03-00D-22-1123
	Blind, Tow Holes	B23-10D-18-1123	B23-10D-20-1123	B23-10D-22-1123
	Standard, No Holes	S23-00D-18-1123	S23-00D-20-1123	S23-00D-22-1123
Tapered Boxed	Standard, Tow Holes	S23-10D-18-1123	S23-10D-20-1123	S23-10D-22-1123
	Blind, No Holes	B04-00D-18-1123	B04-00D-20-1123	B04-00D-22-1123
	Blind, Tow Holes	B24-10D-18-1123	B24-10D-20-1123	B24-10D-22-1123
	Standard, No Holes	S24-00D-18-1123	S24-00D-20-1123	S24-00D-22-1123
Tapered Mitered	Standard, Tow Holes	S24-10D-18-1123	S24-10D-20-1123	S24-10D-22-1123
	Blind, No Holes	B05-00D-18-1123	B05-00D-20-1123	B05-00D-22-1123
	Blind, Tow Holes	B25-10D-18-1123	B25-10D-20-1123	B25-10D-22-1123
	Standard, No Holes	S25-00D-18-1123	S25-00D-20-1123	S25-00D-22-1123
Rolled End	Standard, Tow Holes	S25-10D-18-1123	S25-10D-20-1123	S25-10D-22-1123
	Blind, No Holes	B06-00D-18-1123	B06-00D-20-1123	B06-00D-22-1123
	Blind, Tow Holes	B26-10D-18-1123	B26-10D-20-1123	B26-10D-22-1123
	Standard, No Holes	S26-00D-18-1123	S26-00D-20-1123	S26-00D-22-1123
Rolled End	Standard, Tow Holes	S26-10D-18-1123	S26-00D-20-1124	S26-10D-22-1123

*for Chrome Plated STAINLESS STEEL substitute 5123 for 1123



PETERBILT 379

also fits 357 & 378

Style	Description	18"	20"	22"
Boxed	Blind, No Holes	B01-00D-18-1123	B01-00D-20-1123	B01-00D-22-1123
	Blind, Tow Holes	B11-10D-18-1123	B11-10D-20-1123	B11-10D-22-1123
	Standard, No Holes	S11-00D-18-1123	S11-00D-20-1123	S11-00D-22-1123
	Standard, Tow Holes	S11-10D-18-1123	S11-10D-20-1123	S11-10D-22-1123
Mitered	Blind, No Holes	B02-00D-18-1123	B02-00D-20-1123	B02-00D-22-1123
	Blind, Tow Holes	B12-10D-18-1123	B12-10D-20-1123	B12-10D-22-1123
	Standard, No Holes	S12-00D-18-1123	S12-00D-20-1123	S12-00D-22-1123
	Standard, Tow Holes	S12-10D-18-1123	S12-10D-20-1123	S12-10D-22-1123
American Eagle	Blind, No Holes	B03-00D-18-1123	B03-00D-20-1123	B03-00D-22-1123
	Blind, Tow Holes	B13-10D-18-1123	B13-10D-20-1123	B13-10D-22-1123
	Standard, No Holes	S13-00D-18-1123	S13-00D-20-1123	S13-00D-22-1123
	Standard, Tow Holes	S13-10D-18-1123	S13-10D-20-1123	S13-10D-22-1123
Tapered Boxed	Blind, No Holes	B04-00D-18-1123	B04-00D-20-1123	B04-00D-22-1123
	Blind, Tow Holes	B14-10D-18-1123	B14-10D-20-1123	B14-10D-22-1123
	Standard, No Holes	S14-00D-18-1123	S14-00D-20-1123	S14-00D-22-1123
	Standard, Tow Holes	S14-10D-18-1123	S14-10D-20-1123	S14-10D-22-1123
Tapered Mitered	Blind, No Holes	B05-00D-18-1123	B05-00D-20-1123	B05-00D-22-1123
	Blind, Tow Holes	B15-10D-18-1123	B15-10D-20-1123	B15-10D-22-1123
	Standard, No Holes	S15-00D-18-1123	S15-00D-20-1123	S15-00D-22-1123
	Standard, Tow Holes	S15-10D-18-1123	S15-10D-20-1123	S15-10D-22-1123
Rolled End	Blind, No Holes	B06-00D-18-1123	B06-00D-20-1123	B06-00D-22-1123
	Blind, Tow Holes	B16-10D-18-1123	B16-10D-20-1123	B16-10D-22-1123
	Standard, No Holes	S16-00D-18-1123	S16-00D-20-1123	S16-00D-22-1123
	Standard, Tow Holes	S16-10D-18-1123	S16-10D-20-1123	S16-10D-22-1123

*for Chrome Plated STAINLESS STEEL substitute 5123 for 1123

PETERBILT 359

Style	Description	18"	20"	22"
Boxed	Blind, No Holes	B01-00D-18-1123	B01-00D-20-1123	B01-00D-22-1123
	Blind, Tow Holes	B31-10D-18-1123	B31-10D-20-1123	B31-10D-22-1123
	Standard, No Holes	S31-00D-18-1123	S31-00D-20-1123	S31-00D-22-1123
	Standard, Tow Holes	S31-10D-18-1123	S31-10D-20-1123	S31-10D-22-1123
Mitered	Blind, No Holes	B02-00D-18-1123	B02-00D-20-1123	B02-00D-22-1123
	Blind, Tow Holes	B32-10D-18-1123	B32-10D-20-1123	B32-10D-22-1123
	Standard, No Holes	S32-00D-18-1123	S32-00D-20-1123	S32-00D-22-1123
	Standard, Tow Holes	S32-10D-18-1123	S32-10D-20-1123	S32-10D-22-1123
American Eagle	Blind, No Holes	B03-00D-18-1123	B03-00D-20-1123	B03-00D-22-1123
	Blind, Tow Holes	B33-10D-18-1123	B33-10D-20-1123	B33-10D-22-1123
	Standard, No Holes	S33-00D-18-1123	S33-00D-20-1123	S33-00D-22-1123
	Standard, Tow Holes	S33-10D-18-1123	S33-10D-20-1123	S33-10D-22-1123
Tapered Boxed	Blind, No Holes	B04-00D-18-1123	B04-00D-20-1123	B04-00D-22-1123
	Blind, Tow Holes	B34-10D-18-1123	B34-10D-20-1123	B34-10D-22-1123
	Standard, No Holes	S34-00D-18-1123	S34-00D-20-1123	S34-00D-22-1123
	Standard, Tow Holes	S34-10D-18-1123	S34-10D-20-1123	S34-10D-22-1123
Tapered Mitered	Blind, No Holes	B05-00D-18-1123	B05-00D-20-1123	B05-00D-22-1123
	Blind, Tow Holes	B35-10D-18-1123	B35-10D-20-1123	B35-10D-22-1123
	Standard, No Holes	S35-00D-18-1123	S35-00D-20-1123	S35-00D-22-1123
	Standard, Tow Holes	S35-10D-18-1123	S35-10D-20-1123	S35-10D-22-1123
Rolled End	Blind, No Holes	B06-00D-18-1123	B06-00D-20-1123	B06-00D-22-1123
	Blind, Tow Holes	B36-10D-18-1123	B36-10D-20-1123	B36-10D-22-1123
	Standard, No Holes	S36-00D-18-1123	S36-00D-20-1123	S36-00D-22-1123
	Standard, Tow Holes	S36-10D-18-1123	S36-10D-20-1123	S36-10D-22-1123

*for Chrome Plated STAINLESS STEEL substitute 5123 for 1123



LINCOLN CHROME



TIRED OF POLISHING YOUR STAINLESS BUMPER?

CHROME PLATED CARBON STEEL OR CHROME PLATED STAINLESS STEEL FRONT AND BACK CHROME PLATING COVERAGE



Available in 16" 18" 20" or 22"

CHOOSE QUALITY CHROME

RUN AMERICAN®

KENWORTH W900

W900L, W900B (2010 & older),

Style	Description	18"	20"	22"
Boxed	Blind, No Holes	B01-00D-18-1123	B01-00D-20-1123	B01-00D-22-1123
	Blind, Tow Holes	B41-10D-18-1123	B41-10D-20-1123	B41-10D-22-1123
	Blind, Step Hole Only	B41-20D-18-1123	B41-20D-20-1123	B41-20D-22-1123
	Blind, Step & Tow Holes	B41-30D-18-1123	B41-30D-20-1123	B41-30D-22-1123
	Standard, No Holes	S41-00D-18-1123	S41-00D-20-1123	S41-00D-22-1123
	Standard, Tow Holes	S41-10D-18-1123	S41-10D-20-1123	S41-10D-22-1123
	Standard, Step Hole Only	S41-20D-18-1123	S41-20D-20-1123	S41-20D-22-1123
	Standard, Step & Tow Holes	S41-30D-18-1123	S41-30D-20-1123	S41-30D-22-1123
Mitered	Blind, No Holes	B02-00D-18-1123	B02-00D-20-1123	B02-00D-22-1123
	Blind, Tow Holes	B42-10D-18-1123	B42-10D-20-1123	B42-10D-22-1123
	Blind, Step Hole Only	B42-20D-18-1123	B42-20D-20-1123	B42-20D-22-1123
	Blind, Step & Tow Holes	B42-30D-18-1123	B42-30D-20-1123	B42-30D-22-1123
	Standard, No Holes	S42-00D-18-1123	S42-00D-20-1123	S42-00D-22-1123
	Standard, Tow Holes	S42-10D-18-1123	S42-10D-20-1123	S42-10D-22-1123
	Standard, Step Hole Only	S42-20D-18-1123	S42-20D-20-1123	S42-20D-22-1123
	Standard, Step & Tow Holes	S42-30D-18-1123	S42-30D-20-1123	S42-30D-22-1123
American Eagle	Blind, No Holes	B43-00D-18-1123	B43-00D-20-1123	B43-00D-22-1123
	Blind, Tow Holes	B43-10D-18-1123	B43-10D-20-1123	B43-10D-22-1123
	Blind, Step Hole Only	B43-20D-18-1123	B43-20D-20-1123	B43-20D-22-1123
	Blind, Step & Tow Holes	B43-30D-18-1123	B43-30D-20-1123	B43-30D-22-1123
	Standard, No Holes	S43-00D-18-1123	S43-00D-20-1123	S43-00D-22-1123
	Standard, Tow Holes	S43-10D-18-1123	S43-10D-20-1123	S43-10D-22-1123
	Standard, Step Hole Only	S43-20D-18-1123	S43-20D-20-1123	S43-20D-22-1123
	Standard, Step & Tow Holes	S43-30D-18-1123	S43-30D-20-1123	S43-30D-22-1123

*for Chrome Plated STAINLESS STEEL substitute 5123 for 1123



KENWORTH W900

W900L, W900B (2010 & older),

Style	Description	18"	20"	22"
Tapered Boxed	Blind, No Holes	B04-00D-18-1123	B04-00D-20-1123	B04-00D-22-1123
	Blind, Tow Holes	B44-10D-18-1123	B44-10D-20-1123	B44-10D-22-1123
	Blind, Step Hole Only	B44-20D-18-1123	B44-20D-20-1123	B44-20D-22-1123
	Blind, Step & Tow Holes	B44-30D-18-1123	B44-30D-20-1123	B44-30D-22-1123
	Standard, No Holes	S44-00D-18-1123	S44-00D-20-1123	S44-00D-22-1123
	Standard, Tow Holes	S44-10D-18-1123	S44-10D-20-1123	S44-10D-22-1123
	Standard, Step Hole Only	S44-20D-18-1123	S44-20D-20-1123	S44-20D-22-1123
	Standard, Step & Tow Holes	S44-30D-18-1123	S44-30D-20-1123	S44-30D-22-1123
	Tapered Mitered	Blind, No Holes	B05-00D-18-1123	B05-00D-20-1123
Blind, Tow Holes		B45-10D-18-1123	B45-10D-20-1123	B45-10D-22-1123
Blind, Step Hole Only		B45-20D-18-1123	B45-20D-20-1123	B45-20D-22-1123
Blind, Step & Tow Holes		B45-30D-18-1123	B45-30D-20-1123	B45-30D-22-1123
Standard, No Holes		S45-00D-18-1123	S45-00D-20-1123	S45-00D-22-1123
Standard, Tow Holes		S45-10D-18-1123	S45-10D-20-1123	S45-10D-22-1123
Standard, Step Hole Only		S45-20D-18-1123	S45-20D-20-1123	S45-20D-22-1123
Standard, Step & Tow Holes		S45-30D-18-1123	S45-30D-20-1123	S45-30D-22-1123
Rolled End		Blind, No Holes	B06-00D-18-1123	B06-00D-20-1123
	Blind, Tow Holes	B46-10D-18-1123	B46-10D-20-1123	B46-10D-22-1123
	Blind, Step Hole Only	B46-20D-18-1123	B46-20D-20-1123	B46-20D-22-1123
	Blind, Step & Tow Holes	B46-30D-18-1123	B46-30D-20-1123	B46-30D-22-1123
	Standard, No Holes	S46-00D-18-1123	S46-00D-20-1123	S46-00D-22-1123
	Standard, Tow Holes	S46-10D-18-1123	S46-10D-20-1123	S46-10D-22-1123
	Standard, Step Hole Only	S46-20D-18-1123	S46-20D-20-1123	S46-20D-22-1123
	Standard, Step & Tow Holes	S46-30D-18-1123	S46-30D-20-1123	S46-30D-22-1123

*for Chrome Plated STAINLESS STEEL substitute 5123 for 1123

FREIGHTLINER CLASSIC BUMPERS

1994-2007

Style	Description	18"	20"	22"
1994-2003 Boxed	Blind, No Holes	B01-00D-18-1123	B01-00D-20-1123	B01-00D-22-1123
	Blind, Tow Holes	B61-10D-18-1123	B61-10D-20-1123	B61-10D-22-1123
	Blind, Step Hole Only	B61-20D-18-1123	B61-20D-20-1123	B61-20D-22-1123
	Blind, Step & Tow Holes	B61-30D-18-1123	B61-30D-20-1123	B61-30D-22-1123
	Standard, No Holes	S61-00D-18-1123	S61-00D-20-1123	S61-00D-22-1123
	Standard, Tow Holes	S61-10D-18-1123	S61-10D-20-1123	S61-10D-22-1123
	Standard, Step Hole Only	S61-20D-18-1123	S61-20D-20-1123	S61-20D-22-1123
	Standard, Step & Tow Holes	S61-30D-18-1123	S61-30D-20-1123	S61-30D-22-1123
	2004-2007 Boxed	Blind, No Holes	B01-00D-18-1123	B01-00D-20-1123
Blind, Tow Holes		B71-10D-18-1123	B71-10D-20-1123	B71-10D-22-1123
Blind, Step Hole Only		B71-20D-18-1123	B71-20D-20-1123	B71-20D-22-1123
Blind, Step & Tow Holes		B71-30D-18-1123	B71-30D-20-1123	B71-30D-22-1123
Standard, No Holes		S71-00D-18-1123	S71-00D-20-1123	S71-00D-22-1123
Standard, Tow Holes		S71-10D-18-1123	S71-10D-20-1123	S71-10D-22-1123
Standard, Step Hole Only		S71-20D-18-1123	S71-20D-20-1123	S71-20D-22-1123
Standard, Step & Tow Holes		S71-30D-18-1123	S71-30D-20-1123	S71-30D-22-1123
1994-2003 Mitered		Blind, No Holes	B02-00D-18-1123	B02-00D-20-1123
	Blind, Tow Holes	B62-10D-18-1123	B62-10D-20-1123	B62-10D-22-1123
	Blind, Step Hole Only	B62-20D-18-1123	B62-20D-20-1123	B62-20D-22-1123
	Blind, Step & Tow Holes	B62-30D-18-1123	B62-30D-20-1123	B62-30D-22-1123
	Standard, No Holes	S62-00D-18-1123	S62-00D-20-1123	S62-00D-22-1123
	Standard, Tow Holes	S62-10D-18-1123	S62-10D-20-1123	S62-10D-22-1123
	Standard, Step Hole Only	S62-20D-18-1123	S62-20D-20-1123	S62-20D-22-1123
	Standard, Step & Tow Holes	S62-30D-18-1123	S62-30D-20-1123	S62-30D-22-1123
	2004-2007 Mitered	Blind, No Holes	B72-00D-18-1123	B72-00D-20-1123
Blind, Tow Holes		B72-10D-18-1123	B72-10D-20-1123	B72-10D-22-1123
Blind, Step Hole Only		B72-20D-18-1123	B72-20D-20-1123	B72-20D-22-1123
Blind, Step & Tow Holes		B72-30D-18-1123	B72-30D-20-1123	B72-30D-22-1123
Standard, No Holes		S72-00D-18-1123	S72-00D-20-1123	S72-00D-22-1123
Standard, Tow Holes		S72-10D-18-1123	S72-10D-20-1123	S72-10D-22-1123
Standard, Step Hole Only		S72-20D-18-1123	S72-20D-20-1123	S72-20D-22-1123
Standard, Step & Tow Holes		S72-30D-18-1123	S72-30D-20-1123	S72-30D-22-1123

*for Chrome Plated STAINLESS STEEL substitute 5123 for 1123



FREIGHTLINER CLASSIC

1994-2007

Style	Description	18"	20"	22"
1994-2003 Tapered Boxed	Blind, No Holes	B04-00D-18-1123	B04-00D-20-1123	B04-00D-22-1123
	Blind, Tow Holes	B64-10D-18-1123	B64-10D-20-1123	B64-10D-22-1123
	Blind, Step Hole Only	B64-20D-18-1123	B64-20D-20-1123	B64-20D-22-1123
	Blind, Step & Tow Holes	B64-30D-18-1123	B64-30D-20-1123	B64-30D-22-1123
	Standard, No Holes	S64-00D-18-1123	S64-00D-20-1123	S64-00D-22-1123
	Standard, Tow Holes	S64-10D-18-1123	S64-10D-20-1123	S64-10D-22-1123
	Standard, Step Hole Only	S64-20D-18-1123	S64-20D-20-1123	S64-20D-22-1123
	Standard, Step & Tow Holes	S64-30D-18-1123	S64-30D-20-1123	S64-30D-22-1123
2004-2007 Tapered Boxed	Blind, No Holes	B04-00D-18-1123	B04-00D-20-1123	B04-00D-22-1123
	Blind, Tow Holes	B74-10D-18-1123	B74-10D-20-1123	B74-10D-22-1123
	Blind, Step Hole Only	B74-20D-18-1123	B74-20D-20-1123	B74-20D-22-1123
	Blind, Step & Tow Holes	B74-30D-18-1123	B74-30D-20-1123	B74-30D-22-1123
	Standard, No Holes	S74-00D-18-1123	S74-00D-20-1123	S74-00D-22-1123
	Standard, Tow Holes	S74-10D-18-1123	S74-10D-20-1123	S74-10D-22-1123
	Standard, Step Hole Only	S74-20D-18-1123	S74-20D-20-1123	S74-20D-22-1123
	Standard, Step & Tow Holes	S74-30D-18-1123	S74-30D-20-1123	S74-30D-22-1123
1994-2003 Tapered Mitered	Blind, No Holes	B05-00D-18-1123	B05-00D-20-1123	B05-00D-22-1123
	Blind, Tow Holes	B65-10D-18-1123	B65-10D-20-1123	B65-10D-22-1123
	Blind, Step Hole Only	B65-20D-18-1123	B65-20D-20-1123	B65-20D-22-1123
	Blind, Step & Tow Holes	B65-30D-18-1123	B65-30D-20-1123	B65-30D-22-1123
	Standard, No Holes	S65-00D-18-1123	S65-00D-20-1123	S65-00D-22-1123
	Standard, Tow Holes	S65-10D-18-1123	S65-10D-20-1123	S65-10D-22-1123
	Standard, Step Hole Only	S65-20D-18-1123	S65-20D-20-1123	S65-20D-22-1123
	Standard, Step & Tow Holes	S65-30D-18-1123	S65-30D-20-1123	S65-30D-22-1123
2004-2007 Tapered Mitered	Blind, No Holes	B05-00D-18-1123	B05-00D-20-1123	B05-00D-22-1123
	Blind, Tow Holes	B75-10D-18-1123	B75-10D-20-1123	B75-10D-22-1123
	Blind, Step Hole Only	B75-20D-18-1123	B75-20D-20-1123	B75-20D-22-1123
	Blind, Step & Tow Holes	B75-30D-18-1123	B75-30D-20-1123	B75-30D-22-1123
	Standard, No Holes	S75-00D-18-1123	S75-00D-20-1123	S75-00D-22-1123
	Standard, Tow Holes	S75-10D-18-1123	S75-10D-20-1123	S75-10D-22-1123
	Standard, Step Hole Only	S75-20D-18-1123	S75-20D-20-1123	S75-20D-22-1123
	Standard, Step & Tow Holes	S75-30D-18-1123	S75-30D-20-1123	S75-30D-22-1123

FREIGHTLINER CLASSIC

1994-2007

Style	Description	18"	20"	22"
1994-2003 Rolled End	Blind, No Holes	B06-00D-18-1123	B06-00D-20-1123	B06-00D-22-1123
	Blind, Tow Holes	B66-10D-18-1123	B66-10D-20-1123	B66-10D-22-1123
	Blind, Step Hole Only	B66-20D-18-1123	B66-20D-20-1123	B66-20D-22-1123
	Blind, Step & Tow Holes	B66-30D-18-1123	B66-30D-20-1123	B66-30D-22-1123
	Standard, No Holes	S66-00D-18-1123	S66-00D-20-1123	S66-00D-22-1123
	Standard, Tow Holes	S66-10D-18-1123	S66-10D-20-1123	S66-10D-22-1123
	Standard, Step Hole Only	S66-20D-18-1123	S66-20D-20-1123	S66-20D-22-1123
	Standard, Step & Tow Holes	S66-30D-18-1123	S66-30D-20-1123	S66-30D-22-1123
2004-2007 Rolled End	Blind, No Holes	B06-00D-18-1123	B06-00D-20-1123	B06-00D-22-1123
	Blind, Tow Holes	B76-10D-18-1123	B76-10D-20-1123	B76-10D-22-1123
	Blind, Step Hole Only	B76-20D-18-1123	B76-20D-20-1123	B76-20D-22-1123
	Blind, Step & Tow Holes	B76-30D-18-1123	B76-30D-20-1123	B76-30D-22-1123
	Standard, No Holes	S76-00D-18-1123	S76-00D-20-1123	S76-00D-22-1123
	Standard, Tow Holes	S76-10D-18-1123	S76-10D-20-1123	S76-10D-22-1123
	Standard, Step Hole Only	S76-20D-18-1123	S76-20D-20-1123	S76-20D-22-1123
	Standard, Step & Tow Holes	S76-30D-18-1123	S76-30D-20-1123	S76-30D-22-1123

*for Chrome Plated STAINLESS STEEL substitute 5123 for 1123

*for Chrome Plated STAINLESS STEEL substitute 5123 for 1123



WESTERN STAR

4900SE, 4900EX, CONSTELLATION, LOMAXX ('87-'07)

Style	Description	18"	20"	22"
Boxed	Blind, No Holes	B01-00D-18-1123	B01-00D-20-1123	B01-00D-22-1123
	Blind, Tow Holes	BWA1-10D-18-1123	BWA1-10D-20-1123	BWA1-10D-22-1123
	Standard, No Holes	SWA1-00D-18-1123	SWA1-00D-20-1123	SWA1-00D-22-1123
	Standard, Tow Holes	SWA1-10D-18-1123	SWA1-10D-20-1123	SWA1-10D-22-1123
Mitered	Blind, No Holes	B02-00D-18-1123	B02-00D-20-1123	B02-00D-22-1123
	Blind, Tow Holes	BWA2-10D-18-1123	BWA2-10D-20-1123	BWA2-10D-22-1123
	Standard, No Holes	SWA2-00D-18-1123	SWA2-00D-20-1123	SWA2-00D-22-1123
	Standard, Tow Holes	SWA2-10D-18-1123	SWA2-10D-20-1123	SWA2-10D-22-1123
Tapered Boxed	Blind, No Holes	B04-00D-18-1123	B04-00D-20-1123	B04-00D-22-1123
	Blind, Tow Holes	BWA4-10D-18-1123	BWA4-10D-20-1123	BWA4-10D-22-1123
	Standard, No Holes	SWA4-00D-18-1123	SWA4-00D-20-1123	SWA4-00D-22-1123
	Standard, Tow Holes	SWA4-10D-18-1123	SWA4-10D-20-1123	SWA4-10D-22-1123
Tapered Mitered	Blind, No Holes	B05-00D-18-1123	B05-00D-20-1123	B05-00D-22-1123
	Blind, Tow Holes	BWA5-10D-18-1123	BWA5-10D-20-1123	BWA5-10D-22-1123
	Standard, No Holes	SWA5-00D-18-1123	SWA5-00D-20-1123	SWA5-00D-22-1123
	Standard, Tow Holes	SWA5-10D-18-1123	SWA5-10D-20-1123	SWA5-10D-22-1123
Rolled End	Blind, No Holes	B06-00D-18-1123	B06-00D-20-1123	B06-00D-22-1123
	Blind, Tow Holes	BWA6-10D-18-1123	BWA6-10D-20-1123	BWA6-10D-22-1123
	Standard, No Holes	SWA6-00D-18-1123	SWA6-00D-20-1123	SWA6-00D-22-1123
	Standard, Tow Holes	SWA6-10D-18-1123	SWA6-10D-20-1123	SWA6-10D-22-1123

*for Chrome Plated STAINLESS STEEL substitute 5123 for 1123

WESTERN STAR 4900EX (2008+)

Style	Description	18"	20"	22"
Boxed	Blind, No Holes	B01-00D-18-1123	B01-00D-20-1123	B01-00D-22-1123
	Blind, Tow Holes	BWB1-10D-18-1123	BWB1-10D-20-1123	BWB1-10D-22-1123
	Standard, No Holes	SWB1-00D-18-1123	SWB1-00D-20-1123	SWB1-00D-22-1123
	Standard, Tow Holes	SWB1-10D-18-1123	SWB1-10D-20-1123	SWB1-10D-22-1123
Mitered	Blind, No Holes	B02-00D-18-1123	B02-00D-20-1123	B02-00D-22-1123
	Blind, Tow Holes	BWB2-10D-18-1123	BWB2-10D-20-1123	BWB2-10D-22-1123
	Standard, No Holes	SWB2-00D-18-1123	SWB2-00D-20-1123	SWB2-00D-22-1123
	Standard, Tow Holes	SWB2-10D-18-1123	SWB2-10D-20-1123	SWB2-10D-22-1123
American Eagle	Blind, No Holes	B03-00D-18-1123	B03-00D-20-1123	B03-00D-22-1123
	Blind, Tow Holes	BWB3-10D-18-1123	BWB3-10D-20-1123	BWB3-10D-22-1123
	Standard, No Holes	SWB3-00D-18-1123	SWB3-00D-20-1123	SWB3-00D-22-1123
	Standard, Tow Holes	SWB3-10D-18-1123	SWB3-10D-20-1123	SWB3-10D-22-1123
Tapered Boxed	Blind, No Holes	B04-00D-18-1123	B04-00D-20-1123	B04-00D-22-1123
	Blind, Tow Holes	BWB4-10D-18-1123	BWB4-10D-20-1123	BWB4-10D-22-1123
	Standard, No Holes	SWB4-00D-18-1123	SWB4-00D-20-1123	SWB4-00D-22-1123
	Standard, Tow Holes	SWB4-10D-18-1123	SWB4-10D-20-1123	SWB4-10D-22-1123
Tapered Mitered	Blind, No Holes	B05-00D-18-1123	B05-00D-20-1123	B05-00D-22-1123
	Blind, Tow Holes	BWB5-10D-18-1123	BWB5-10D-20-1123	BWB5-10D-22-1123
	Standard, No Holes	SWB5-00D-18-1123	SWB5-00D-20-1123	SWB5-00D-22-1123
	Standard, Tow Holes	SWB5-10D-18-1123	SWB5-10D-20-1123	SWB5-10D-22-1123
Rolled End	Blind, No Holes	B06-00D-18-1123	B06-00D-20-1123	B06-00D-22-1123
	Blind, Tow Holes	BWB6-10D-18-1123	BWB6-10D-20-1123	BWB6-10D-22-1123
	Standard, No Holes	SWB6-00D-18-1123	SWB6-00D-20-1123	SWB6-00D-22-1123
	Standard, Tow Holes	SWB6-10D-18-1123	SWB6-10D-20-1123	SWB6-10D-22-1123

*for Chrome Plated STAINLESS STEEL substitute 5123 for 1123



WESTERN STAR 4700SF (2013+)

Pre-Drilled Light Hole Options Available

Full Catalog Online



SCAN HERE FOR OPTIONS

Style	Description	18"	20"	22"
Boxed	Blind, No Holes	B01-00D-18-1123	B01-00D-20-1123	B01-00D-22-1123
	Blind, Tow Holes	BWC1-10D-18-1123	BWC1-10D-20-1123	BWC1-10D-22-1123
	Standard, No Holes	SWC1-00D-18-1123	SWC1-00D-20-1123	SWC1-00D-22-1123
	Standard, Tow Holes	SWC1-10D-18-1123	SWC1-10D-20-1123	SWC1-10D-22-1123
Mitered	Blind, No Holes	B02-00D-18-1123	B02-00D-20-1123	B02-00D-22-1123
	Blind, Tow Holes	BWC2-10D-18-1123	BWC2-10D-20-1123	BWC2-10D-22-1123
	Standard, No Holes	SWC2-00D-18-1123	SWC2-00D-20-1123	SWC2-00D-22-1123
	Standard, Tow Holes	SWC2-10D-18-1123	SWC2-10D-20-1123	SWC2-10D-22-1123
American Eagle	Blind, No Holes	B03-00D-18-1123	B03-00D-20-1123	B03-00D-22-1123
	Blind, Tow Holes	BWC3-10D-18-1123	BWC3-10D-20-1123	BWC3-10D-22-1123
	Standard, No Holes	SWC3-00D-18-1123	SWC3-00D-20-1123	SWC3-00D-22-1123
	Standard, Tow Holes	SWC3-10D-18-1123	SWC3-10D-20-1123	SWC3-10D-22-1123
Tapered Boxed	Blind, No Holes	B04-00D-18-1123	B04-00D-20-1123	B04-00D-22-1123
	Blind, Tow Holes	BWC4-10D-18-1123	BWC4-10D-20-1123	BWC4-10D-22-1123
	Standard, No Holes	SWC4-00D-18-1123	SWC4-00D-20-1123	SWC4-00D-22-1123
	Standard, Tow Holes	SWC4-10D-18-1123	SWC4-10D-20-1123	SWC4-10D-22-1123
Tapered Mitered	Blind, No Holes	B05-00D-18-1123	B05-00D-20-1123	B05-00D-22-1123
	Blind, Tow Holes	BWC5-10D-18-1123	BWC5-10D-20-1123	BWC5-10D-22-1123
	Standard, No Holes	SWC5-00D-18-1123	SWC5-00D-20-1123	SWC5-00D-22-1123
	Standard, Tow Holes	SWC5-10D-18-1123	SWC5-10D-20-1123	SWC5-10D-22-1123
Rolled End	Blind, No Holes	B06-00D-18-1123	B06-00D-20-1123	B06-00D-22-1123
	Blind, Tow Holes	BWC6-10D-18-1123	BWC6-10D-20-1123	BWC6-10D-22-1123
	Standard, No Holes	SWC6-00D-18-1123	SWC6-00D-20-1123	SWC6-00D-22-1123
	Standard, Tow Holes	SWC6-10D-18-1123	SWC6-10D-20-1123	SWC6-10D-22-1123

*for Chrome Plated STAINLESS STEEL substitute 5123 for 1123

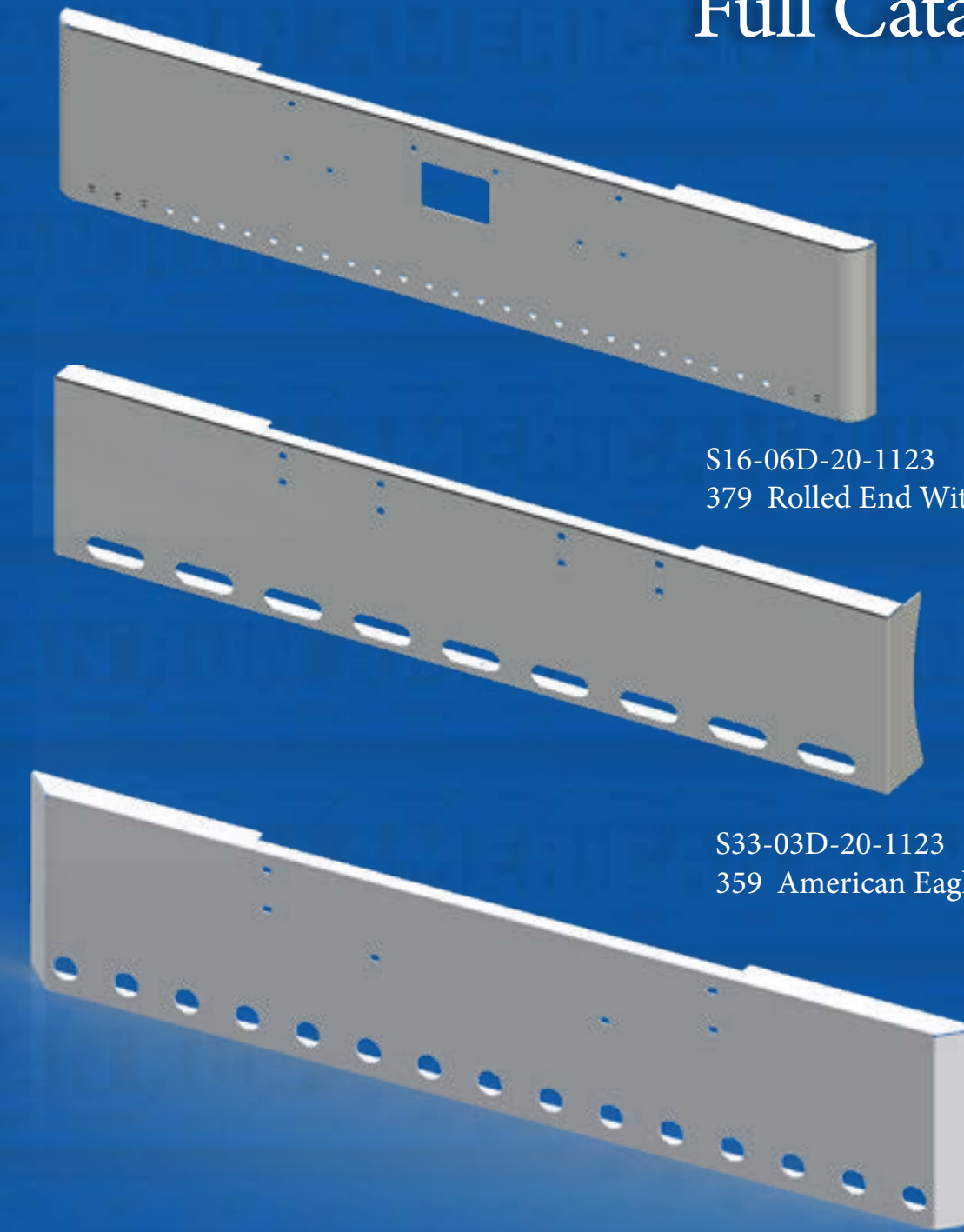

S16-06D-20-1123
379 Rolled End With (29) Dime Lights

S33-03D-20-1123
359 American Eagle (9) Oval Light Holes

S42-01D-20-1123
W900 Mitered with (15) 2" Circle Lights

WATERMELON LIGHT HOLES | 15 3/4" LIGHT HOLES | 31 3/4" LIGHT HOLES
15 2" LIGHT HOLES | 9 OVAL LIGHT HOLES



BLIND MOUNTING PLATES

PETERBILT & KENWORTH

PB 379, PB 389, KW W900, & KW W990

Part Number	Description
BM-PBKW-BM18	18"
BM-PBKW-BM20	20"
BM-PBKW-BM22	22"

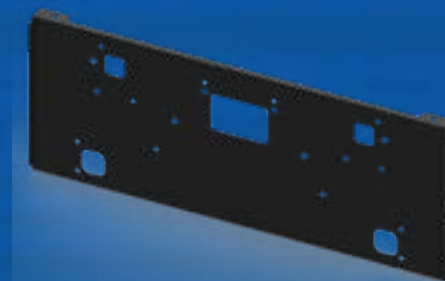

FREIGHTLINER CLASSIC

1994 - 2003 & 2004 -2007

Part Number	Description
BM-FWI-18-PC	18"
BM-FWI-20-PC	20"
BM-FWI-22-PC	22"

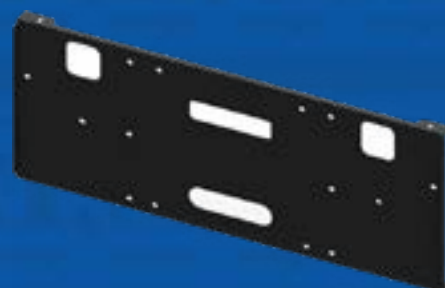

PETERBILT

PB 359

Part Number	Description
BM-FWI-18-PC	18"
BM-FWI-20-PC	20"
BM-FWI-22-PC	22"

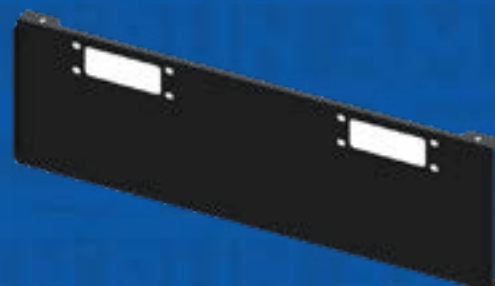

WESTERN STAR

4900, 4900EX, CONSTELLATION, LOMAXX, & 4700SF

Part Number	Description
BM-WS1-18-PC	18"
BM-WS1-20-PC	20"
BM-WS1-22-PC	22"

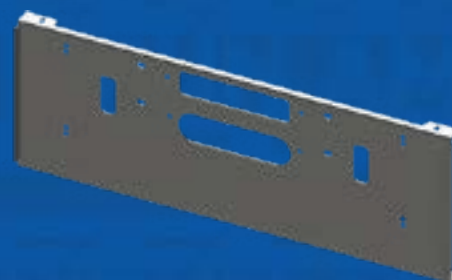

BUMPER ACCESSORIES

BUMPER SUPPORT BRACKETS

Part Number	Description
BS1-16-20	16"-20" Peterbilt 379 Bumper Supports with Watermelon Hole
BS1-20-22	20"-22" Peterbilt 379 Bumper Supports with Watermelon Hole
BS2-16-20	16"-20" Peterbilt 389 & 589 Bumper Supports with Watermelon Hole
BS2-20-22	20"-22" Peterbilt 389 & 589 Bumper Supports with Watermelon Hole
BS4-18	18" Kenworth W900 Bumper Supports with Watermelon Hole
BS4-20	20" Kenworth W900 Bumper Supports with Watermelon Hole
BS4-22	22" Kenworth W900 Bumper Supports with Watermelon Hole





VISORS



CHROME VISORS

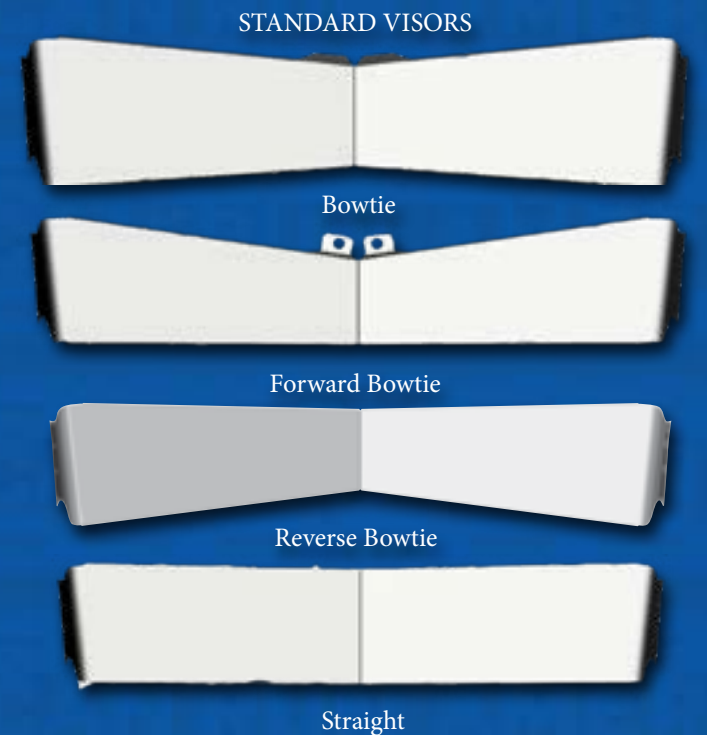
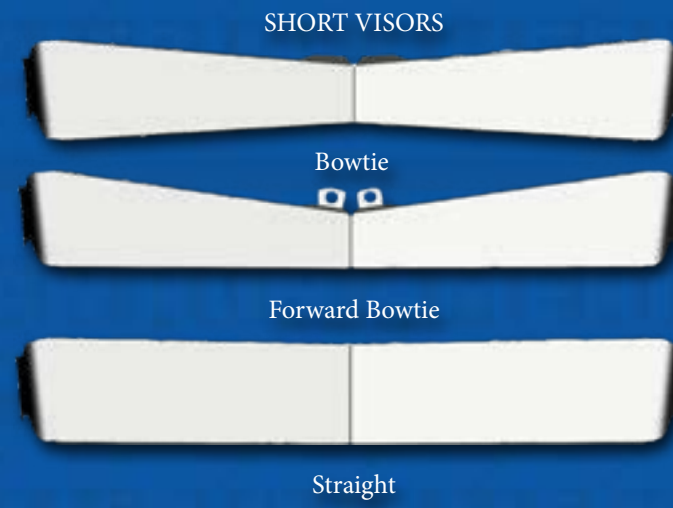

Truck Type	Chrome Plated Stainless Steel Part Number	Stainless Steel Part Number	Part Description
Peterbilt 589 (Flat Top Only)		V021-14-12A-2102	14"/12" Reverse Bowtie - Factory Visor Mount
		V021-14-12B-2102	14"/12" Reverse Bowtie - No Factory Visor
		V024-14-14A-2102	14" Straight - Forward Visor Mount
		V014-12-14B-2102	14" Straight - No Factory Visor
Peterbilt 379, 388, 389 Standard Visor	V011-12-08-2103	V011-12-08-2105	12"/8" Reverse Bowtie Visor Kit
	V012-12-08-2103	V012-12-08-2105	12"/8" Bowtie Visor Kit
	V013-12-08-2103	V013-12-08-2105	12"/8" Forward Bowtie Visor Kit
	V014-12-12-2103	V014-12-12-2105	12" Straight Visor Kit
Peterbilt 379, 388, 389 Short Visor	V012-09-05-2103	V012-09-05-2105	9"/5" Bowtie Visor Kit
	V013-09-05-2103	V013-09-05-2105	9"/5" Forward Bowtie Visor Kit
	V014-09-09-2103	V014-09-09-2105	9" Straight Visor Kit
Kenworth W900 Curved Windshield Standard Visor	V041-13-09-2103	V041-13-09-2105	13"/9" Reverse Bowtie Visor Kit
	V042-13-09-2103	V042-13-09-2105	13"/9" Bowtie Visor Kit
	V043-13-09-2103	V043-13-09-2105	13"/9" Forward Bowtie Visor Kit
	V044-13-13-2103	V044-13-13-2105	13" Straight Visor Kit
Kenworth W900 Curved Windshield Short Visor	V042-10-06-2103	V042-10-06-2105	10"/6" Bowtie Visor Kit
	V043-10-06-2103	V043-10-06-2105	10"/6" Forward Bowtie Visor Kit
	V044-10-10-2103	V044-10-10-2105	10" Straight Visor Kit
Kenworth W900 Flat Windshield Standard Visor	V051-13-09-2103	V051-13-09-2105	13"/9" Reverse Bowtie Visor Kit
	V052-13-09-2103	V052-13-09-2105	13"/9" Bowtie Visor Kit
	V053-13-09-2103	V053-13-09-2105	13"/9" Forward Bowtie Visor Kit
	V054-13-13-2103	V054-13-13-2105	13" Straight Visor Kit
Kenworth W900 Flat Windshield Short Visor	V052-10-06-2103	V052-10-06-2105	10"/6" Bowtie Visor Kit
	V053-10-06-2103	V053-10-06-2105	10"/6" Forward Bowtie Visor Kit
	V054-10-10-2103	V054-10-10-2105	10" Straight Visor Kit



CHROME PLATED STAINLESS STEEL ACCESSORIES

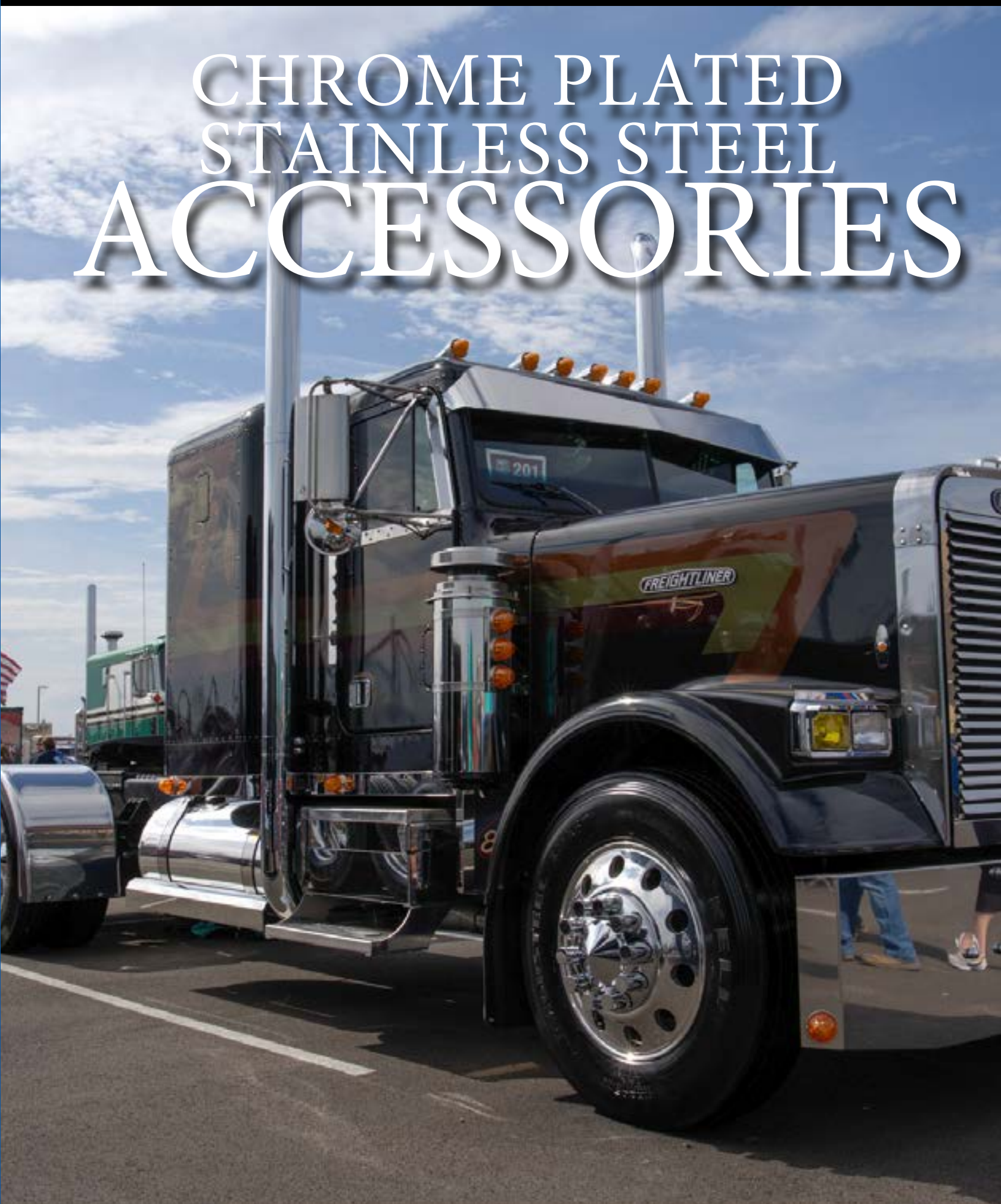

GRAB HANDLES

STAINLESS STEEL GRAB HANDLES

Length	Style	Part Number
48"	Stainless Steel	GB-048-5003

10" DIAMETER - 270° WRAP AROUND HEAT SHIELDS

Part Number Includes (1) Shield + (2) Mounting Clamps



Diameter	Style	Part Number
5	Circle Perforated	HSK10-048-5102
6	Circle Perforated	HSK10-048-5102-6
7	Circle Perforated	HSK10-048-5102-7

Diameter	Style	Part Number
5	Vertical Slot Perforated	HSL10-048-5102
6	Vertical Slot Perforated	HSL10-048-5102-6
7	Vertical Slot Perforated	HSL10-048-5102-7



180° STAINLESS STEEL HEAT SHIELDS

Part Number Includes (1) Shield + (2) Mounting Clamps

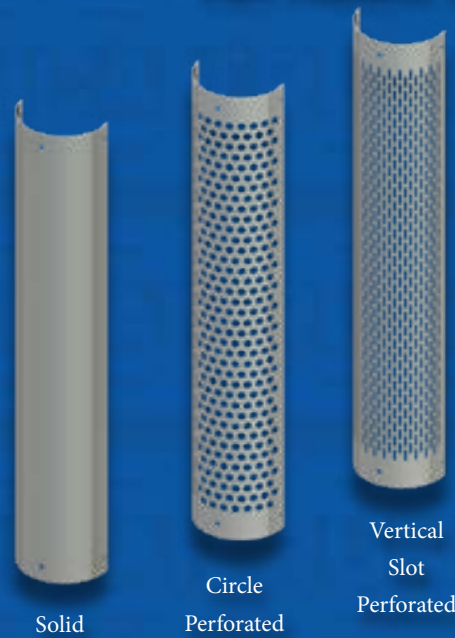

Diameter	Style	Part Number
5	Solid	HSJ05-048-5102
6	Solid	HSJ06-048-5102
7	Solid	HSJ07-048-5102
8	Solid	HSJ08-048-5102

Diameter	Style	Part Number
5	Circle Perforated	HSK05-048-5102
6	Circle Perforated	HSK06-048-5102
7	Circle Perforated	HSK07-048-5102
8	Circle Perforated	HSK08-048-5102

Diameter	Style	Part Number
5	Vertical Slot Perforated	HSL05-048-5102
6	Vertical Slot Perforated	HSL06-048-5102
7	Vertical Slot Perforated	HSL07-048-5102
8	Vertical Slot Perforated	HSL08-048-5102

GRAB HANDLE MOUNTING CLAMPS



Diameter	Part Number
5	45-08053
6	45-08063
7	45-08073
8	45-08083

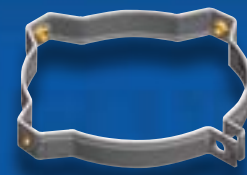

INTERIOR HEAT SHIELD MOUNTING CLAMP

Diameter	Part Number
5	45-09056
6	45-09066
7	45-09076
8	45-09086

EXTERIOR ACCESSORIES



Flat Permit Panel Single Under Plate Holder Single Permit Kit Double Permit Kit Tow Pin Bracket Kit

Part Number	Description
ACC-LPP-4X4TPM-5062	18G 304 SS 4"X4" Flat Permit Panel Tape Mount
ACC-LPP-4X8TPM-5062	18G 304 SS 4"X8" Flat Permit Panel Tape Mount
ACC-LPP-SNGPLT-5042	14G 304 SS Single Under Plate Holder
ACC-LPP-STSGKT-5022	10G 304 SS Peterbilt Stack Single Permit Kit
ACC-LPP-STDBKT-5022	10G 304 SS Peterbilt Stack Double Permit Kit
ACC-BRK-TOWPN-5042	14G 304 SS Peterbilt 389 Tow Pin Bracket Kit

CHROME LIGHT BARS

10 Hole Light Bar



6 Hole Light Bar



Part Number	Description
LB-54-LPA-5123	10G 304 SS Light Bar with 10 Light Holes
LB-34-XXX-5123	10G 304 SS Light Bar with 6 Light Holes



CHROME PLATED BILLET ALUMINUM OIL CAPS

Part Number	Description
LC-HUB-A1	4.5" Bolt Pattern, Front Steer Wheels, Sold in Pairs.



GRILLES

Part Number	Description
G2-120-5052	16G Peterbilt 389 & 589 Round & Stag Grille Insert
G2-220-5052	16G Peterbilt 389 & 589 Oval Grille Insert
G2-410-5042	14G Peterbilt 389 & 589 Plain Rectangle Grille Insert
G2-420-5042	14G Peterbilt 389 & 589 Staggered Rectangle Grille Insert
G4-410-5042	14G Kenworth W900 Horizontal Grille Insert
G4-420-5042	14G Kenworth W900 Staggered Grille Insert

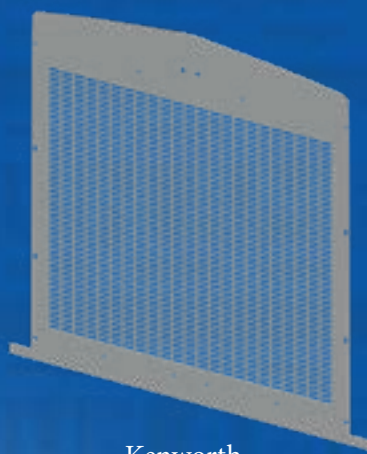

Kenworth

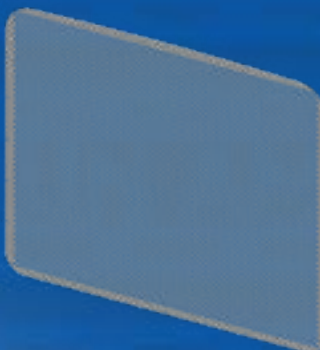

Peterbilt

MUDFLAP WEIGHTS

Part Number	Description
ACC-MFA-STD18-5042	11G SS Anti Sail Standard 18" Pair
ACC-MFB-STD24-5042	11G SS Standard 24" Bottom Flap Pair
ACC-MFB-CUR24-5042	11G SS Curved 24" Bottom Flap Pair
ACC-MFB-TRB24-5042	11G SS Tribal 24" Bottom Flap Pair
ACC-MFB-USA24-5042	11G SS Run American 24" Bottom Flap Pair

- Polished hardware included

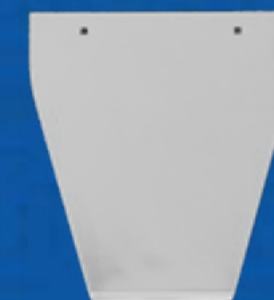

Anti Sail Standard



Standard



Curved



Tribal



Run American



LINCOLN
C H R O M E



CHROME PLATED BILLET ALUMINUM FRONT OIL CAP

- ▶ 4.50 Inch Bolt Pattern
- ▶ Front Steer Wheels
- ▶ Sold in Pairs
- ▶ Includes Vented Seals, Gaskets and Bolts for Installation
- ▶ Looks Great, Lasts Longer



THANK YOU

We are grateful to our loyal customers for continuing to choose Lincoln Chrome. Thank you for supporting our brand, interacting on social media, and tagging us in your photos. We love seeing your Lincoln Chrome on the road, feel free to send your truck images to CS@lincolnchrome.com for a chance to be featured!



FOLLOW US



@LincolnChrome



@LincolnChromeUSA



@LincolnChrome



THE ONLY FULLY CHROME-PLATED BUMPER ON THE MARKET

**TRUSTED BY THE BEST.
70+ YEARS OF CHROME PLATING.
LOOKS GREAT. LASTS LONGER.
SUPERIOR CUSTOMER SERVICE.
MADE IN AMERICA.**

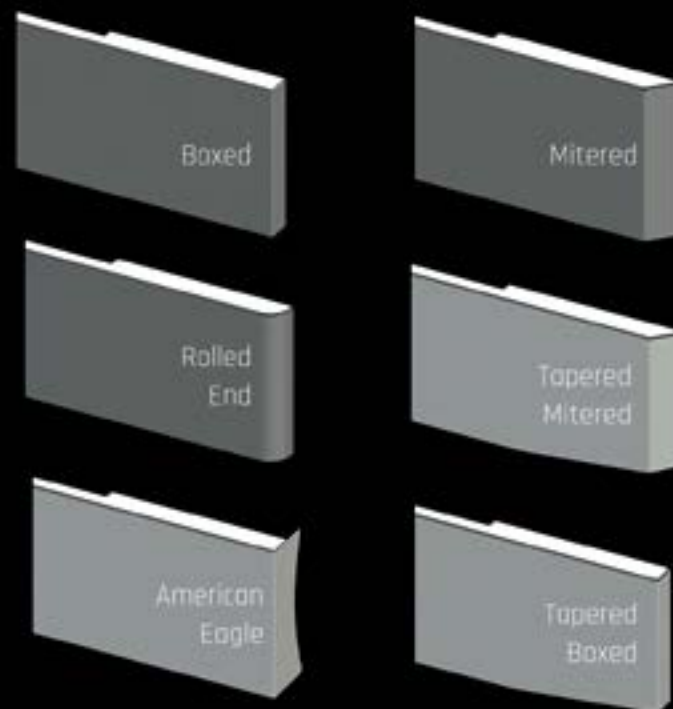

CONTACT US



LINCOLNCHROME.COM
888-966-6609



GENERAL INFORMATION

AUTHORIZED DISTRIBUTOR

Lincoln Chrome has many first-class distributors throughout the country. To find a distributor, please visit the website at www.lincolnchrome.com and view the "Contact Us" page. To become an authorized distributor, please contact Customer Service.

CHANGING AN ORDER

If you need to change your order, contact Customer Service. Please have the order number ready. Please note, if your order has already been processed, you may not be able to cancel or modify it.

EMAIL AND PHONE ORDERS

Online ordering is preferred, but authorized dealers may place orders via email, fax, or phone. To increase accuracy, all phone orders must be followed up by an email or fax with PO number to be considered valid. Email and Fax orders will not be considered valid until order confirmation is received. You can email orders to cs@lincolnchrome.com. Before calling, please have the part number(s) and purchase order number ready.

FREIGHT, HANDLING, TAXES, DUTIES AND INSURANCE

Prices do not include taxes, customs and duties, or insurance, all of which shall be paid by the customer. Insuring of the product is the responsibility of the customer.

SHIPPING METHODS

Orders shipped by Lincoln Chrome are FOB destination. Note: Residential and OCONUS shipments will require additional shipping fees as required and are not included in prepaid shipping.

Orders will be shipped by a carrier determined by Lincoln Chrome. Orders for products in stock will generally ship within 72 hours of order confirmation. Emergency orders can be placed until 12:00 PM central time and all attempts will be made to ship same day if in stock; although Lincoln Chrome cannot guarantee an emergency order will ship the same day ordered. An expediting charge may be applied for emergency orders. Unless otherwise agreed in writing, Lincoln Chrome may deliver products ordered in installments. Any delivery or anticipated shipment dates are estimates only. Lincoln Chrome shall not be liable for, and expressly disclaims any liability for any loss, damage, cost or expense associated in any way with any failure to delivery in accordance with any specific delivery schedule or shipment date. Anything herein to the contrary notwithstanding, all shipments are subject to product availability. Products that are out of stock may not be available for immediate shipment. Further, Lincoln Chrome specifically reserves the right to curtail or cease to manufacture and/or sell any product at any time without liability or prior notice.

TITLE AND RISK OF LOSS

Title and risk of loss shall pass to the customer upon delivery of the products to carrier at Lincoln Chrome's facilities.

RETURNS

All exchanges and returns require a Return Materials Authorization number which can be obtained by contacting Customer Service. All returned products must be in resalable condition and in their original packaging. Product and



packaging cannot be damaged or marked. Returns will be authorized for standard stocking items purchased within 90 days of the return request. Return requests for non-standard products, products purchased more than 90 days prior to the return request and items classified as obsolete, slow moving or non-stocking will be reviewed to determine demand and Lincoln Chrome may either grant or deny a return authorization for such items in its sole discretion. All returns will be subject to a 25% restocking charge. Return shipping charges must be paid by customer. Items returned without prior approval will be refused. Lincoln Chrome reserves the right to deny any return based on any criteria it may determine to be appropriate. After authorization of the return and receipt, inspection and acceptance of the products, credit, net the applicable restocking charge, will be issued at the current sale price or the sale price paid at the time of purchase, whichever is less.

LIMITED WARRANTY

Lincoln Chrome warrants that products sold by Lincoln Chrome shall be free from defects in material and workmanship under normal use and service for a period of two (2) year from the date of purchase. During said two (2) year period, Lincoln Chrome will repair or replace any goods which are defective and which are returned to Lincoln Chrome with transportation charges prepaid. Product needs to be installed by a qualified professional. Except as set forth above, Lincoln Chrome expressly disclaims and makes no other warranties or representations of any kind, whether express or implied, as to the quality, condition, or marketability of the products, specifically including, but not limited to, any warranty arising under any statute, common law, case law, commercial usage, custom or otherwise, or any express or implied warranty of merchantability or fitness for any particular purpose, all of which are hereby expressly excluded.

LIMITATION OF LIABILITY

The customer's sole remedy with respect to any claims arising in connection with any products purchased from Lincoln Chrome is to return the product under the return policy set forth above. Under no circumstances, including, but not limited to negligence, shall Lincoln Chrome be liable for any direct, indirect, special, incidental, or consequential damages, including, but not limited to, failure of essential purpose, defect, or loss of use of any kind even if Lincoln Chrome or its affiliates have been advised of the possibility of such damages. Suppose any law or court finds this litigation or liability or any part of it unenforceable. In that case, the customer's sole remedy shall be a refund of the purchase price for the product.

CATALOG ACCURACY

The catalog information is furnished for the convenience of our customers. Lincoln Chrome makes no guarantee, either expressed or implied, as to the accuracy of any information provided in the catalog. Any representations set forth in the catalog as to product use or application are for illustrative purposes only and are not designed or intended to be relied upon by customers who purchase the product.

GOVERNING LAW

The laws of the State of Nebraska will govern these terms and conditions, and the sale of all goods and services furnished to Customer in connection herewith without giving effect to any principles of conflicts of laws.

ENTIRE AGREEMENT

The terms and conditions set forth above are superseded and replaced all prior agreements and understandings, whether written or oral, relating thereto, and constitute the entire agreement of the parties with respect to the subject matter hereof and these terms and conditions may not be supplemented, altered or modified by the use of any other documents, and any attempt to modify these terms and conditions will be null and void unless agreed to in writing by an authorized officer of Lincoln Chrome.



**TRUSTED BY THE BEST.
70+ YEARS OF CHROME PLATING.
LOOKS GREAT. LASTS LONGER.
SUPERIOR CUSTOMER SERVICE.
MADE IN AMERICA.**



EXHAUST | BUMPERS | VISORS | ACCESSORIES





888.966.6609 • LINCOLNCHROME.COM • MADE IN LINCOLN, NEBRASKA

RUN AMERICAN[®]